

SPILLSTENSILER

Kragerøcupen 2008, 23.-24. august 2008

Mappen: 1(1)

Runden: 1

Nord / Ingen

♠ J75
♥ QJT52
♦ 62
♣ QJ3

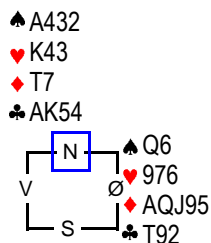

♠ KT98
♥ A8
♦ K843
♣ 876

Bord	NS	ØV	NS	ØV	NS	ØV
10	31	10 2 Ruter D	Ø 5	500	17,0	-17,0
4	37	4 2 Ruter D	Ø 5	500	17,0	-17,0
15	26	15 3 Hjerter D	V 6	500	17,0	-17,0
2	39	2 4 Spar	S 10	420	5,0	-5,0
3	38	3 4 Spar	S 10	420	5,0	-5,0
7	34	7 4 Spar	N 10	420	5,0	-5,0
1	40	1 4 Spar	S 10	420	5,0	-5,0
11	11	30 4 Spar	N 10	420	5,0	-5,0
20	21	20 4 Spar	S 10	420	5,0	-5,0
12	29	12 4 Spar	S 10	420	5,0	-5,0
13	28	13 4 Spar	N 10	420	5,0	-5,0
17	17	24 4 Spar	N 10	420	5,0	-5,0
14	14	27 2 Spar	N 10	170	-9,0	9,0
8	33	8 2 Spar	N 10	170	-9,0	9,0
16	25	16 2 Spar	N 10	170	-9,0	9,0
6	35	6 2 Spar	N 10	170	-9,0	9,0
19	19	22 2 Spar	S 10	170	-9,0	9,0
9	9	32 1 NT	S 9	150	-16,0	16,0
18	18	23 2 NT	N 9	150	-16,0	16,0
5	5	36 1 NT	N 7	90	-19,0	19,0

Mappen: 2(2)

Runden: 1

Øst / N/S

♠ T9654
♥ 2
♦ AT83
♣ QJ6

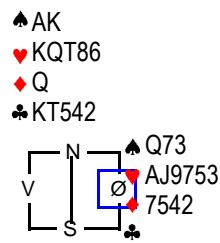

♠ J82
♥ 4
♦ KJ96
♣ A9873

Bord	NS	ØV	NS	ØV	NS	ØV
11	11	30 4 Hjerter D	Ø 5	1100	19,0	-19,0
19	19	22 3 NT	N 10	630	16,0	-16,0
15	26	15 3 NT	N 10	630	16,0	-16,0
5	5	36 3 NT	N 9	600	8,0	-8,0
6	35	6 3 NT	N 9	600	8,0	-8,0
8	33	8 3 NT	N 9	600	8,0	-8,0
1	40	1 3 NT	N 9	600	8,0	-8,0
18	18	23 5 Kløver	N 11	600	8,0	-8,0
4	37	4 5 Kløver	N 11	600	8,0	-8,0
10	31	10 2 Hjerter D	V 5	500	1,0	-1,0
13	28	13 2 Hjerter	Ø 3	250	-1,0	1,0
3	38	3 2 Hjerter	Ø 4	200	-3,0	3,0
12	29	12 2 Hjerter	V 5	150	-5,0	5,0
7	34	7 2 Hjerter	Ø 6	100	-9,0	9,0
16	25	16 2 Hjerter	Ø 6	100	-9,0	9,0
9	9	32 2 Hjerter	Ø 6	100	-9,0	9,0
14	14	27 5 Kløver	S 10	100	-15,0	15,0
2	39	2 5 Kløver	S 10	100	-15,0	15,0
17	17	24 6 Kløver	N 11	100	-15,0	15,0
20	21	20 5 Kløver D	S 10	200	-19,0	19,0

Mappen: 3(3)

Runden: 1

Syd / Ø/V

♠ AKT2
♥ A3
♦ Q642
♣ 872

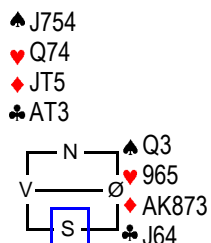

♠ 986
♥ KJT82
♦ 9
♣ KQ95

Bord	NS	ØV	NS	ØV	NS	ØV
20	21	20 4 Ruter	V 9	100	19,0	-19,0
11	11	30 3 Hjerter	S 8	50	14,0	-14,0
3	38	3 3 Hjerter	S 8	50	14,0	-14,0
7	34	7 3 Hjerter	S 8	50	14,0	-14,0
10	31	10 3 Hjerter	S 8	50	14,0	-14,0
9	9	32 3 Ruter	Ø 9	110	9,0	-9,0
15	26	15 3 Ruter	V 10	130	2,0	-2,0
13	28	13 3 Ruter	V 10	130	2,0	-2,0
12	29	12 3 Ruter	V 10	130	2,0	-2,0
4	37	4 3 Ruter	V 10	130	2,0	-2,0
14	14	27 4 Ruter	Ø 10	130	2,0	-2,0
6	35	6 4 Ruter	V 10	130	2,0	-2,0
1	40	1 1 NT	Ø 9	150	-7,0	7,0
5	5	36 1 NT	Ø 9	150	-7,0	7,0
2	39	2 1 NT	Ø 9	150	-7,0	7,0
16	25	16 2 NT	V 10	180	-13,0	13,0
8	33	8 2 NT	V 10	180	-13,0	13,0
18	18	23 2 NT	V 10	180	-13,0	13,0
19	19	22 4 Hjerter D	S 8	300	-17,0	17,0
17	17	24 3 NT	V 9	600	-19,0	19,0

Mappen: 4(4)

Runden: 2

Vest / Alle

♠ JT75
♥ A98
♦ J3
♣ J972

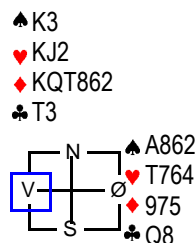

♠ Q94
♥ Q53
♦ A4
♣ AK654

Bord	NS	ØV	NS	ØV	NS	ØV
18	19	24 3 NT	N 12	690	19,0	-19,0
4	38	5 3 NT	S 11	660	14,0	-14,0
17	18	25 3 NT	S 11	660	14,0	-14,0
16	26	17 3 NT	S 11	660	14,0	-14,0
14	15	28 3 NT	S 11	660	14,0	-14,0
11	12	31 3 NT	S 10	630	5,0	-5,0
10	32	11 3 NT	S 10	630	5,0	-5,0
12	30	13 3 NT	S 10	630	5,0	-5,0
19	20	23 3 NT	S 10	630	5,0	-5,0
9	10	33 3 NT	S 10	630	5,0	-5,0
13	29	14 3 NT	S 9	600	-10,0	10,0
20	22	21 3 NT	S 9	600	-10,0	10,0
15	27	16 3 NT	S 9	600	-10,0	10,0
1	40	2 3 NT	S 9	600	-10,0	10,0
8	34	9 3 NT	S 9	600	-10,0	10,0
7	35	8 3 NT	S 9	600	-10,0	10,0
6	36	7 3 NT	S 9	600	-10,0	10,0
5	6	37 3 NT	S 9	600	-10,0	10,0
3	39	4 3 NT	S 9	600	-10,0	10,0
2	1	3 3 NT	S 9	600	-10,0	10,0

SPILLSTENSILER

Kragerøcupen 2008, 23.-24. august 2008

Mappnr: 5(5)

Rundenr: 2

Nord / N/S

♠ KJ2
♥ 73
♦ J52
♣ AKQ62

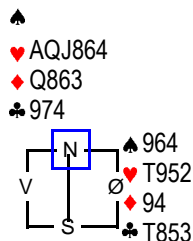

Bord	NS	ØV	NS	ØV	NS	ØV
15	27	16	6 Hjerter	N 12	1430	19,0 -19,0
2	1	3	6 Ruter	S 12	1370	15,0 -15,0
16	26	17	6 Ruter	S 12	1370	15,0 -15,0
13	29	14	6 Ruter	N 12	1370	15,0 -15,0
10	32	11	5 Kløver D	V 6	1100	11,0 -11,0
3	39	4	4 Spar D	S 10	790	9,0 -9,0
4	38	5	4 Hjerter	N 12	680	7,0 -7,0
5	6	37	4 Spar	S 10	620	-4,0 4,0
6	36	7	4 Spar	S 10	620	-4,0 4,0
7	35	8	4 Spar	S 10	620	-4,0 4,0
11	12	31	4 Spar	S 10	620	-4,0 4,0
20	22	21	4 Spar	S 10	620	-4,0 4,0
12	30	13	4 Spar	S 10	620	-4,0 4,0
14	15	28	4 Spar	S 10	620	-4,0 4,0
17	18	25	4 Spar	S 10	620	-4,0 4,0
18	19	24	4 Spar	S 10	620	-4,0 4,0
19	20	23	4 Spar	S 10	620	-4,0 4,0
1	40	2	3 Spar	S 10	170	-16,0 16,0
9	10	33	3 Spar	S 10	170	-16,0 16,0
8	34	9	6 Spar	S 10	200	-19,0 19,0

Mappnr: 6(6)

Rundenr: 2

Øst / Ø/V

♠ KT9876
♥ 7
♦ 82
♣ 9874

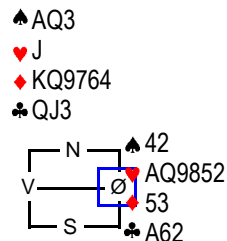

Bord	NS	ØV	NS	ØV	NS	ØV
10	32	11	3 NT	S 11	460	11,0 -11,0
19	20	23	3 NT	S 11	460	11,0 -11,0
18	19	24	3 NT	N 11	460	11,0 -11,0
15	27	16	3 NT	S 11	460	11,0 -11,0
14	15	28	3 NT	S 11	460	11,0 -11,0
13	29	14	3 NT	S 11	460	11,0 -11,0
12	30	13	3 NT	S 11	460	11,0 -11,0
4	38	5	3 NT	S 11	460	11,0 -11,0
8	34	9	3 NT	S 11	460	11,0 -11,0
17	18	25	3 NT	S 10	430	-1,0 1,0
20	22	21	3 NT	N 10	430	-1,0 1,0
5	6	37	3 NT	S 10	430	-1,0 1,0
7	35	8	2 Spar D	V 7	200	-5,0 5,0
2	1	3	3 Ruter	N 11	150	-11,0 11,0
3	39	4	3 Ruter	N 11	150	-11,0 11,0
6	36	7	3 Ruter	N 11	150	-11,0 11,0
1	40	2	3 Ruter	N 11	150	-11,0 11,0
11	12	31	3 Ruter	N 11	150	-11,0 11,0
9	10	33	6 Ruter	N 11	50	-17,0 17,0
16	26	17	1 Spar D	V 7	160	-19,0 19,0

Mappnr: 7(7)

Rundenr: 3

Syd / Alle

♠ 82
♥ Q8
♦ J
♣ AQT98632

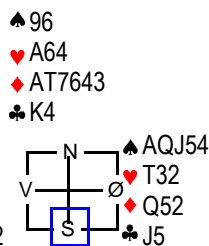

Bord	NS	ØV	NS	ØV	NS	ØV
9	11	34	5 Kløver D	V 8	800	17,0 -17,0
19	21	24	5 Kløver D	V 8	800	17,0 -17,0
17	19	26	5 Kløver D	V 8	800	17,0 -17,0
12	31	14	4 Hjerter	S 10	620	13,0 -13,0
11	13	32	4 Kløver D	V 8	500	9,0 -9,0
13	30	15	4 Kløver D	V 8	500	9,0 -9,0
4	39	6	5 Kløver D	V 9	500	9,0 -9,0
14	16	29	4 Kløver D	V 9	200	2,0 -2,0
18	20	25	4 Kløver	V 8	200	2,0 -2,0
3	1	5	4 Kløver	V 8	200	2,0 -2,0
2	2	4	4 Kløver D	V 9	200	2,0 -2,0
5	7	38	3 Hjerter	S 10	170	-3,0 3,0
8	35	10	3 Ruter	N 11	150	-5,0 5,0
7	36	9	3 Hjerter	S 9	140	-8,0 8,0
10	33	12	3 Hjerter	S 9	140	-8,0 8,0
15	28	17	3 Ruter	N 10	130	-11,0 11,0
20	23	22	4 Hjerter	N 9	100	-13,0 13,0
1	40	3	4 Hjerter	S 8	200	-16,0 16,0
6	37	8	4 Hjerter	S 8	200	-16,0 16,0
16	27	18	5 Hjerter	S 8	300	-19,0 19,0

Mappnr: 8(8)

Rundenr: 3

Vest / Ingen

♠ KQ843
♥ A9
♦ T865
♣ Q7

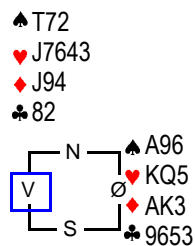

Bord	NS	ØV	NS	ØV	NS	ØV
8	35	10	3 NT	Ø 8	50	8,0 -8,0
11	13	32	4 Spar	V 9	50	8,0 -8,0
2	2	4	4 Spar	V 9	50	8,0 -8,0
18	20	25	4 Spar	V 9	50	8,0 -8,0
3	1	5	4 Spar	V 9	50	8,0 -8,0
16	27	18	4 Spar	V 9	50	8,0 -8,0
15	28	17	4 Spar	V 9	50	8,0 -8,0
4	39	6	4 Spar	V 9	50	8,0 -8,0
13	30	15	4 Spar	V 9	50	8,0 -8,0
12	31	14	4 Spar	V 9	50	8,0 -8,0
6	37	8	4 Spar	Ø 9	50	8,0 -8,0
1	40	3	4 Spar	V 9	50	8,0 -8,0
5	7	38	4 Hjerter	V 10	420	-6,0 6,0
7	36	9	4 Spar	V 10	420	-6,0 6,0
10	33	12	4 Spar	V 11	450	-14,0 14,0
20	23	22	4 Spar	V 11	450	-14,0 14,0
14	16	29	4 Spar	V 11	450	-14,0 14,0
17	19	26	4 Spar	V 11	450	-14,0 14,0
9	11	34	4 Spar	V 11	450	-14,0 14,0
19	21	24	5 Spar	V 11	450	-14,0 14,0

SPILLSTENSILER

Kragerøcupen 2008, 23.-24. august 2008

Mappen: 9(9)

Runden: 3

Nord / ØV

- ♠ A3
- ♥ KQ542
- ♦ K973
- ♣ J3

♠ K865

♥ 98

♦ AT

♣ Q9765

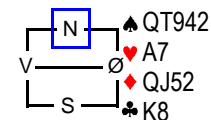

♠ J7

♥ JT63

♦ 864

♣ AT42

Bord	NS	ØV	NS	ØV	NS	ØV
4	39	6 3 NT	Ø 6	300	18,0	-18,0
7	36	9 4 Spar	Ø 7	300	18,0	-18,0
16	27	18 2 Spar	Ø 7	100	-1,0	1,0
13	30	15 3 NT	Ø 8	100	-1,0	1,0
5	7	38 3 NT	Ø 8	100	-1,0	1,0
6	37	8 3 NT	Ø 8	100	-1,0	1,0
1	40	3 3 NT	Ø 8	100	-1,0	1,0
3	1	5 3 NT	Ø 8	100	-1,0	1,0
12	31	14 3 NT	Ø 8	100	-1,0	1,0
11	13	32 3 NT	Ø 8	100	-1,0	1,0
2	2	4 3 NT	Ø 8	100	-1,0	1,0
15	28	17 3 NT	Ø 8	100	-1,0	1,0
17	19	26 3 NT	Ø 8	100	-1,0	1,0
18	20	25 3 NT	Ø 8	100	-1,0	1,0
19	21	24 3 NT	Ø 8	100	-1,0	1,0
20	23	22 3 NT	V 8	100	-1,0	1,0
8	35	10 4 Hjerter	V 9	100	-1,0	1,0
10	33	12 5 Ruter	Ø 10	100	-1,0	1,0
9	11	34 5 Ruter	Ø 10	100	-1,0	1,0
14	16	29 3 NT	Ø 9	600	-19,0	19,0

Mappen: 10(10)

Runden: 4

Øst / Alle

- ♠ Q75
- ♥ AJ
- ♦ 543
- ♣ AT864

♠

♥ QT76432

♦ Q972

♣ Q2

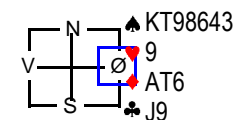

Bord	NS	ØV	NS	ØV	NS	ØV
14	17	30 4 Hjerter	N 11	650	18,0	-18,0
4	1	7 4 Hjerter	N 11	650	18,0	-18,0
11	14	33 4 Hjerter	S 10	620	10,0	-10,0
3	2	6 4 Hjerter	S 10	620	10,0	-10,0
15	29	18 4 Hjerter	N 10	620	10,0	-10,0
12	32	15 4 Hjerter	N 10	620	10,0	-10,0
7	37	10 4 Hjerter	N 10	620	10,0	-10,0
1	40	4 4 Hjerter	N 10	620	10,0	-10,0
19	22	25 4 Spar D	Ø 9	200	2,0	-2,0
17	20	27 4 Spar D	V 9	200	2,0	-2,0
2	3	5 4 Spar	Ø 9	100	-1,0	1,0
5	8	39 5 Hjerter	N 10	100	-5,0	5,0
10	34	13 5 Hjerter	N 10	100	-5,0	5,0
13	31	16 5 Hjerter	N 10	100	-5,0	5,0
6	38	9 3 Spar	Ø 9	140	-9,0	9,0
18	21	26 5 Hjerter D	N 10	200	-11,0	11,0
16	28	19 4 Spar	Ø 11	650	-14,0	14,0
9	12	35 4 Spar	Ø 11	650	-14,0	14,0
20	24	23 4 Spar D	Ø 10	790	-17,0	17,0
8	36	11 4 Spar D	V 11	990	-19,0	19,0

Mappen: 11(11)

Runden: 4

Syd / Ingen

- ♠ KT3
- ♥ 4
- ♦ 642
- ♣ J98652

♠ Q97

♥ A63

♦ AKT83

♣ K4

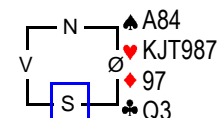

♠ J652

♥ Q52

♦ QJ5

♣ AT7

Bord	NS	ØV	NS	ØV	NS	ØV
16	28	19 3 NT	N 11	460	19,0	-19,0
18	21	26 3 NT	N 10	430	8,0	-8,0
4	1	7 3 NT	N 10	430	8,0	-8,0
15	29	18 3 NT	N 10	430	8,0	-8,0
14	17	30 3 NT	N 10	430	8,0	-8,0
13	31	16 3 NT	N 10	430	8,0	-8,0
12	32	15 3 NT	S 10	430	8,0	-8,0
20	24	23 3 NT	N 10	430	8,0	-8,0
5	8	39 3 NT	N 10	430	8,0	-8,0
1	40	4 3 NT	N 10	430	8,0	-8,0
8	36	11 3 NT	N 10	430	8,0	-8,0
11	14	33 3 NT	N 9	400	-7,0	7,0
2	3	5 3 NT	N 9	400	-7,0	7,0
6	38	9 3 NT	S 9	400	-7,0	7,0
10	34	13 3 NT	N 9	400	-7,0	7,0
9	12	35 3 NT	N 9	400	-7,0	7,0
3	2	6 2 Hjerter D	Ø 6	300	-14,0	14,0
19	22	25 3 Kløver D	V 7	300	-14,0	14,0
7	37	10 3 NT	N 7	100	-18,0	18,0
17	20	27 3 NT	S 7	100	-18,0	18,0

Mappen: 12(12)

Runden: 4

Vest / N/S

- ♠ 9532
- ♥ 5
- ♦ KQJT764
- ♣ 6

♠ J864

♥ J9

♦ 53

♣ Q9832

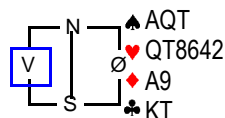

♠ K7

♥ AK73

♦ 82

♣ AJ754

Bord	NS	ØV	NS	ØV	NS	ØV
14	17	30 5 Ruter D	V 9	300	19,0	-19,0
7	37	10 5 Ruter D	V 10	100	17,0	-17,0
17	20	27 3 NT	Ø 8	50	14,0	-14,0
3	2	6 4 Ruter	V 9	50	14,0	-14,0
19	22	25 3 Ruter	V 9	110	11,0	-11,0
13	31	16 2 Spar	N 6	200	9,0	-9,0
6	38	9 2 Spar	N 5	300	7,0	-7,0
11	14	33 3 NT	Ø 9	400	3,0	-3,0
5	8	39 3 NT	Ø 9	400	3,0	-3,0
8	36	11 3 NT	Ø 9	400	3,0	-3,0
12	32	15 4 Hjerter	Ø 10	420	-1,0	1,0
4	1	7 3 NT	Ø 10	430	-8,0	8,0
10	34	13 3 NT	Ø 10	430	-8,0	8,0
20	24	23 3 NT	Ø 10	430	-8,0	8,0
16	28	19 3 NT	Ø 10	430	-8,0	8,0
18	21	26 3 NT	Ø 10	430	-8,0	8,0
9	12	35 3 NT	Ø 10	430	-8,0	8,0
1	40	4 3 NT D	Ø 9	550	-16,0	16,0
15	29	18 3 NT D	Ø 9	550	-16,0	16,0
2	3	5 3 NT D	Ø 10	650	-19,0	19,0

SPILLSTENSILER

Kragerøcupen 2008, 23.-24. august 2008

Mappnr: 13(13)

Rundenr: 5

Nord / Alle

- ♠ 9875
- ♥ A8
- ♦ 82
- ♣ AK852

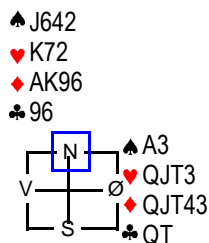

Bord	NS	ØV	NS	ØV	NS	ØV
8	37	12 2 NT	Ø 6	200	16,0	-16,0
11	15	34 3 NT	Ø 7	200	16,0	-16,0
1	40	5 3 NT	Ø 7	200	16,0	-16,0
5	9	1 4 Ruter	Ø 8	200	16,0	-16,0
2	4	6 2 Kløver	V 7	100	11,0	-11,0
19	23	26 Pass			9,0	-9,0
15	30	19 1 NT	Ø 7	90	6,0	-6,0
14	18	31 2 Ruter	Ø 8	90	6,0	-6,0
16	29	20 1 NT	N 6	100	3,0	-3,0
4	2	8 1 NT	Ø 8	120	-1,0	1,0
7	38	11 1 NT	Ø 8	120	-1,0	1,0
13	32	17 2 NT	Ø 8	120	-1,0	1,0
3	3	7 1 NT	Ø 9	150	-5,0	5,0
10	35	14 1 NT	Ø 10	180	-10,0	10,0
18	22	27 1 NT	Ø 10	180	-10,0	10,0
9	13	36 1 NT	Ø 10	180	-10,0	10,0
17	21	28 2 NT	Ø 10	180	-10,0	10,0
20	25	24 2 Ruter	N 6	200	-15,0	15,0
6	39	10 3 NT	Ø 10	630	-18,0	18,0
12	33	16 3 NT	Ø 10	630	-18,0	18,0

Mappnr: 14(14)

Rundenr: 5

Øst / Ingen

- ♠ QJ
- ♥ KQT953
- ♦ 8752
- ♣ 9

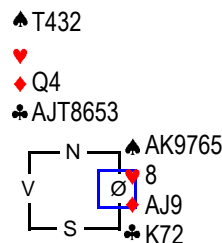

Bord	NS	ØV	NS	ØV	NS	ØV
17	21	28 4 Kløver D	N 10	510	19,0	-19,0
13	32	17 3 Kløver D	N 9	470	11,0	-11,0
16	29	20 3 Kløver D	N 9	470	11,0	-11,0
15	30	19 3 Kløver D	N 9	470	11,0	-11,0
14	18	31 3 Kløver D	N 9	470	11,0	-11,0
5	9	1 3 Kløver D	N 9	470	11,0	-11,0
3	3	7 3 Kløver D	N 9	470	11,0	-11,0
4	2	8 3 Kløver D	N 9	470	11,0	-11,0
9	13	36 4 Spar	Ø 8	100	2,0	-2,0
6	39	10 4 Spar D	Ø 9	100	2,0	-2,0
8	37	12 3 Spar	Ø 8	50	-4,0	4,0
7	38	11 3 Spar	Ø 8	50	-4,0	4,0
19	23	26 4 Spar	Ø 9	50	-4,0	4,0
2	4	6 4 Spar	Ø 9	50	-4,0	4,0
12	33	16 2 Spar	Ø 9	140	-10,0	10,0
20	25	24 3 Spar	Ø 9	140	-10,0	10,0
10	35	14 5 Kløver D	N 9	300	-13,0	13,0
1	40	5 3 NT	Ø 9	400	-15,0	15,0
18	22	27 4 Spar	Ø 10	420	-17,0	17,0
11	15	34 2 Hjerter D	S 4	800	-19,0	19,0

Mappnr: 15(15)

Rundenr: 5

Syd / N/S

- ♠ 432
- ♥ K4
- ♦ 9843
- ♣ KQ75

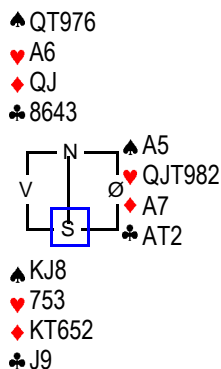

Bord	NS	ØV	NS	ØV	NS	ØV
18	22	27 3 NT	Ø 8	50	18,0	-18,0
4	2	8 3 NT	V 8	50	18,0	-18,0
3	3	7 2 NT	V 8	120	15,0	-15,0
2	4	6 2 Hjerter	Ø 10	170	9,0	-9,0
16	29	20 2 Hjerter	Ø 10	170	9,0	-9,0
12	33	16 2 Hjerter	Ø 10	170	9,0	-9,0
9	13	36 3 Hjerter	Ø 10	170	9,0	-9,0
20	25	24 3 Hjerter	Ø 10	170	9,0	-9,0
13	32	17 1 NT	Ø 10	180	3,0	-3,0
14	18	31 2 Hjerter	Ø 11	200	-1,0	1,0
8	37	12 2 Hjerter	Ø 11	200	-1,0	1,0
19	23	26 3 Hjerter	Ø 11	200	-1,0	1,0
15	30	19 1 NT	Ø 11	210	-6,0	6,0
6	39	10 1 NT	Ø 11	210	-6,0	6,0
10	35	14 4 Hjerter	Ø 10	420	-10,0	10,0
17	21	28 4 Hjerter	Ø 10	420	-10,0	10,0
11	15	34 3 NT	V 10	430	-13,0	13,0
7	38	11 4 Hjerter	Ø 11	450	-17,0	17,0
5	9	1 4 Hjerter	Ø 11	450	-17,0	17,0
1	40	5 4 Hjerter	Ø 11	450	-17,0	17,0

Mappnr: 16(16)

Rundenr: 6

Vest / ØV

- ♠ 732
- ♥ AJ74
- ♦ AK85
- ♣ KJ

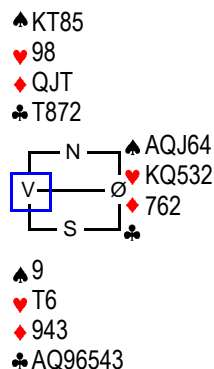

Bord	NS	ØV	NS	ØV	NS	ØV
20	26	25 6 Spar D	V 11	200	19,0	-19,0
3	4	8 7 Hjerter	V 12	100	16,0	-16,0
15	31	20 7 Hjerter	V 12	100	16,0	-16,0
18	23	28 4 Spar	V 11	650	11,0	-11,0
6	1	11 4 Spar	V 11	650	11,0	-11,0
1	40	6 5 Spar	V 11	650	11,0	-11,0
17	22	29 4 Hjerter	Ø 12	680	3,0	-3,0
13	33	18 4 Hjerter	Ø 12	680	3,0	-3,0
5	10	2 4 Hjerter	Ø 12	680	3,0	-3,0
7	39	12 4 Hjerter	Ø 12	680	3,0	-3,0
14	19	32 5 Hjerter	V 12	680	3,0	-3,0
10	36	15 7 Kløver D	S 7	1400	-3,0	3,0
2	5	7 6 Hjerter	Ø 12	1430	-11,0	11,0
4	3	9 6 Hjerter	Ø 12	1430	-11,0	11,0
8	38	13 6 Hjerter	Ø 12	1430	-11,0	11,0
11	16	35 6 Hjerter	V 12	1430	-11,0	11,0
16	30	21 6 Hjerter	V 12	1430	-11,0	11,0
19	24	27 6 Hjerter	V 12	1430	-11,0	11,0
9	14	37 6 Hjerter	V 12	1430	-11,0	11,0
12	34	17 6 Hjerter	Ø 13	1460	-19,0	19,0

SPILLSTENSILER

Kragerøcupen 2008, 23.-24. august 2008

Mappen: 17(17)

Runden: 6

Nord / Ingen

- ♠ J9
- ♥ KT85
- ♦ K432
- ♣ AJ6

♠ A8654

♥ A9642

♦ Q

♣ 43

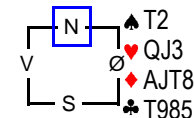

♠ KQ73

♥ 7

♦ 9765

♣ KQ72

Bord	NS	ØV	NS	ØV	NS	ØV
18	23	28	4 Spar	N 11	450	17,0 -17,0
17	22	29	4 Spar	S 11	450	17,0 -17,0
1	40	6	4 Spar	N 11	450	17,0 -17,0
3	4	8	4 Spar	N 10	420	5,0 -5,0
4	3	9	4 Spar	N 10	420	5,0 -5,0
14	19	32	4 Spar	N 10	420	5,0 -5,0
5	10	2	4 Spar	N 10	420	5,0 -5,0
12	34	17	4 Spar	N 10	420	5,0 -5,0
20	26	25	4 Spar	N 10	420	5,0 -5,0
6	1	11	4 Spar	N 10	420	5,0 -5,0
8	38	13	4 Spar	N 10	420	5,0 -5,0
7	39	12	4 Spar	N 10	420	5,0 -5,0
15	31	20	2 Spar	S 11	200	-5,0 5,0
11	16	35	2 Spar	N 10	170	-11,0 11,0
10	36	15	3 Spar	N 10	170	-11,0 11,0
13	33	18	3 Spar	S 10	170	-11,0 11,0
16	30	21	3 Spar	N 10	170	-11,0 11,0
9	14	37	3 Spar	S 10	170	-11,0 11,0
2	5	7	3 Spar	N 9	140	-17,0 17,0
19	24	27	4 Spar	N 9	50	-19,0 19,0

Mappen: 18(18)

Runden: 6

Øst / N/S

- ♠ A965
- ♥ A2
- ♦ AKQ4
- ♣ K63

♠ T

♥ KQT9754

♦ T972

♣ 5

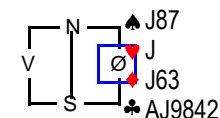

♠ KQ432

♥ 863

♦ 85

♣ QT7

Bord	NS	ØV	NS	ØV	NS	ØV
6	1	11	6 NT	V 7	250	18,0 -18,0
15	31	20	6 NT	V 7	250	18,0 -18,0
11	16	35	3 NT	V 8	50	2,0 -2,0
2	5	7	3 NT	V 8	50	2,0 -2,0
3	4	8	3 NT	V 8	50	2,0 -2,0
4	3	9	3 NT	V 8	50	2,0 -2,0
7	39	12	3 NT	V 8	50	2,0 -2,0
1	40	6	3 NT	V 8	50	2,0 -2,0
10	36	15	3 NT	V 8	50	2,0 -2,0
12	34	17	3 NT	V 8	50	2,0 -2,0
16	30	21	3 NT	V 8	50	2,0 -2,0
18	23	28	3 NT	V 8	50	2,0 -2,0
9	14	37	3 NT	V 8	50	2,0 -2,0
5	10	2	6 Kløver	Ø 11	50	2,0 -2,0
17	22	29	6 Kløver	Ø 11	50	2,0 -2,0
19	24	27	6 Kløver	V 11	50	2,0 -2,0
20	26	25	3 Hjerter D	N 8	200	-13,0 13,0
13	33	18	5 Kløver	V 11	400	-16,0 16,0
8	38	13	5 Kløver	Ø 11	400	-16,0 16,0
14	19	32	4 Hjerter D	N 8	500	-19,0 19,0

Mappen: 19(19)

Runden: 7

Syd / ØV

- ♠ AT6
- ♥ KJ8743
- ♦ Q84
- ♣ 3

♠ KQ85

♥ 65

♦ KT95

♣ A62

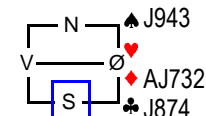

♠ 72

♥ AQT92

♦ 6

♣ KQT95

Bord	NS	ØV	NS	ØV	NS	ØV
10	37	16	3 NT	N 10	430	13,0 -13,0
5	11	3	3 NT	N 10	430	13,0 -13,0
17	23	30	3 NT	N 10	430	13,0 -13,0
15	32	21	3 NT	N 10	430	13,0 -13,0
14	20	33	3 NT	N 10	430	13,0 -13,0
7	1	13	3 NT	N 10	430	13,0 -13,0
12	35	18	3 NT	N 10	430	13,0 -13,0
3	5	9	3 NT	N 9	400	2,0 -2,0
6	2	12	3 NT	N 9	400	2,0 -2,0
11	17	36	3 NT	N 9	400	2,0 -2,0
16	31	22	3 NT	N 9	400	2,0 -2,0
8	39	14	3 Kløver	S 9	110	-3,0 3,0
1	40	7	3 NT	N 8	50	-7,0 7,0
2	6	8	3 NT	N 8	50	-7,0 7,0
9	15	38	3 NT	N 8	50	-7,0 7,0
18	24	29	2 Hjerter D	S 7	100	-14,0 14,0
13	34	19	3 NT	N 7	100	-14,0 14,0
4	4	10	3 NT	N 7	100	-14,0 14,0
19	25	28	3 NT	N 7	100	-14,0 14,0
20	27	26	5 Kløver	S 8	150	-19,0 19,0

Mappen: 20(20)

Runden: 7

Vest / Alle

- ♠ 963
- ♥ 973
- ♦ K43
- ♣ K862

♠ JT2

♥ A

♦ AQ965

♣ AT75

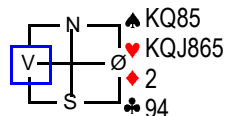

♠ A74

♥ T42

♦ JT87

♣ QJ3

Bord	NS	ØV	NS	ØV	NS	ØV
19	25	28	3 NT	N 10	630	18,0 -18,0
4	4	10	3 NT	N 10	630	18,0 -18,0
12	35	18	3 Hjerter D	Ø 7	500	15,0 -15,0
9	15	38	3 Hjerter	Ø 7	200	10,0 -10,0
18	24	29	3 Hjerter	Ø 7	200	10,0 -10,0
2	6	8	3 Hjerter	Ø 7	200	10,0 -10,0
20	27	26	4 Hjerter	Ø 8	200	10,0 -10,0
5	11	3	3 Ruter	N 11	150	2,0 -2,0
8	39	14	3 Ruter	N 11	150	2,0 -2,0
3	5	9	4 Ruter	N 11	150	2,0 -2,0
10	37	16	4 Ruter	N 11	150	2,0 -2,0
1	40	7	3 Ruter	N 10	130	-8,0 8,0
6	2	12	3 Ruter	N 10	130	-8,0 8,0
17	23	30	3 Ruter	N 10	130	-8,0 8,0
13	34	19	4 Ruter	N 10	130	-8,0 8,0
14	20	33	4 Ruter	N 10	130	-8,0 8,0
16	31	22	4 Ruter	N 10	130	-8,0 8,0
11	17	36	2 NT	S 8	120	-15,0 15,0
15	32	21	2 Spar	N 8	110	-17,0 17,0
7	1	13	2 Hjerter	Ø 8	110	-19,0 19,0

SPILLSTENSILER

Kragerøcupen 2008, 23.-24. august 2008

Mappnr: 21(21)
Rundenr: 7

Nord / N/S

♠ QJ6
♥ AJ2
♦ 8754
♣ JT6

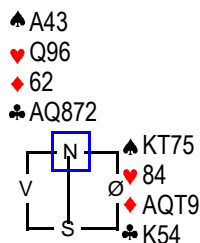

♠ 982
♥ KT753
♦ KJ3
♣ 93

Bord	NS	ØV	NS	ØV	NS	ØV
16	31	22	3 Ruter D	Ø 7	300	18,9 -18,9
6	2	12	1 NT	V 4	150	16,8 -16,8
10	37	16	2 Hjerter	S 9	140	13,7 -13,7
14	20	33	3 Hjerter	S 9	140	13,7 -13,7
11	17	36	2 Hjerter	S 8	110	10,5 -10,5
13	34	19	4 Ruter	Ø 8	100	8,4 -8,4
5	11	3	1 NT	N 7	90	6,3 -6,3
9	15	38	60%-60%			3,8 3,8
3	5	9	2 Ruter	V 7	50	3,2 -3,2
4	4	10	3 Ruter	Ø 8	50	3,2 -3,2
17	23	30	1 NT	N 6	100	-3,2 3,2
8	39	14	2 Hjerter	S 7	100	-3,2 3,2
18	24	29	2 Kløver	N 7	100	-3,2 3,2
20	27	26	3 Hjerter	S 8	100	-3,2 3,2
19	25	28	3 Ruter	V 10	130	-8,4 8,4
15	32	21	1 NT D	V 7	180	-10,5 10,5
12	35	18	3 Hjerter	S 7	200	-15,8 15,8
1	40	7	3 Hjerter D	S 8	200	-15,8 15,8
7	1	13	3 Hjerter	N 7	200	-15,8 15,8
2	6	8	3 Hjerter	S 7	200	-15,8 15,8

Mappnr: 22(22)
Rundenr: 8

Øst / Ø/V

♠ KJ72
♥ K98742
♦ K6
♣ 3

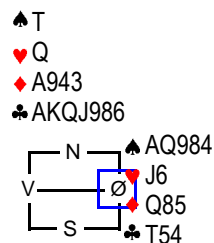

♠ 653
♥ AT53
♦ JT72
♣ 72

Bord	NS	ØV	NS	ØV	NS	ØV
14	21	34	5 Kløver D	N 11	550	19,0 -19,0
20	28	27	4 Hjerter D	V 8	500	17,0 -17,0
11	18	37	3 NT	S 9	400	11,0 -11,0
19	26	29	3 NT	N 9	400	11,0 -11,0
2	7	9	3 NT	N 9	400	11,0 -11,0
5	12	4	5 Kløver	N 11	400	11,0 -11,0
6	3	13	5 Kløver	N 11	400	11,0 -11,0
4	5	11	5 Spar	Ø 9	200	5,0 -5,0
18	25	30	3 Kløver	N 11	150	-2,0 2,0
16	32	23	3 Kløver	N 11	150	-2,0 2,0
17	24	31	4 Kløver	N 11	150	-2,0 2,0
13	35	20	4 Kløver	N 11	150	-2,0 2,0
12	36	19	4 Kløver	N 11	150	-2,0 2,0
7	2	14	4 Kløver	N 11	150	-2,0 2,0
10	38	17	4 Spar	Ø 9	100	-9,0 9,0
8	1	15	3 NT	N 8	50	-12,0 12,0
9	16	39	3 NT	S 8	50	-12,0 12,0
3	6	10	5 Kløver D	N 10	100	-15,0 15,0
15	33	22	4 Spar	V 10	620	-17,0 17,0
1	40	8	4 Spar D	V 10	790	-19,0 19,0

Mappnr: 23(23)
Rundenr: 8

Syd / Alle

♠ J64
♥ J4
♦ AQ954
♣ AT9

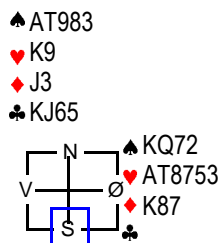

♠ 5
♥ Q62
♦ T62
♣ Q87432

Bord	NS	ØV	NS	ØV	NS	ØV
10	38	17	3 NT	Ø 7	200	15,0 -15,0
20	28	27	5 Ruter	V 9	200	15,0 -15,0
3	6	10	6 Ruter	V 10	200	15,0 -15,0
12	36	19	6 Ruter	V 10	200	15,0 -15,0
13	35	20	6 Ruter	V 10	200	15,0 -15,0
11	18	37	5 Hjerter	Ø 10	100	9,0 -9,0
18	25	30	2 Hjerter	Ø 10	170	5,0 -5,0
2	7	9	2 Hjerter	Ø 10	170	5,0 -5,0
5	12	4	3 Hjerter	Ø 10	170	5,0 -5,0
15	33	22	4 Hjerter	Ø 10	620	-4,0 4,0
17	24	31	4 Hjerter	Ø 10	620	-4,0 4,0
1	40	8	4 Hjerter	Ø 10	620	-4,0 4,0
7	2	14	4 Hjerter	Ø 10	620	-4,0 4,0
6	3	13	4 Hjerter	Ø 10	620	-4,0 4,0
9	16	39	4 Hjerter	Ø 10	620	-4,0 4,0
8	1	15	4 Hjerter	Ø 11	650	-11,0 11,0
14	21	34	3 NT	Ø 11	660	-15,0 15,0
16	32	23	3 NT	V 11	660	-15,0 15,0
4	5	11	3 NT	Ø 11	660	-15,0 15,0
19	26	29	4 Hjerter	V 12	680	-19,0 19,0

Mappnr: 24(24)
Rundenr: 8

Vest / Ingen

♠ A2
♥ KT654
♦ 72
♣ T876

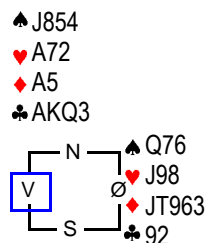

♠ KT93
♥ Q3
♦ KQ84
♣ J54

Bord	NS	ØV	NS	ØV	NS	ØV
14	21	34	6 Spar	S 12	980	19,0 -19,0
12	36	19	3 Hjerter D	V 5	800	17,0 -17,0
11	18	37	4 Spar	S 12	480	5,0 -5,0
2	7	9	4 Spar	N 12	480	5,0 -5,0
3	6	10	4 Spar	S 12	480	5,0 -5,0
7	2	14	4 Spar	S 12	480	5,0 -5,0
10	38	17	4 Spar	S 12	480	5,0 -5,0
20	28	27	4 Spar	S 12	480	5,0 -5,0
13	35	20	4 Spar	N 12	480	5,0 -5,0
15	33	22	4 Spar	S 12	480	5,0 -5,0
18	25	30	4 Spar	N 12	480	5,0 -5,0
19	26	29	4 Spar	S 12	480	5,0 -5,0
9	16	39	4 Spar	S 12	480	5,0 -5,0
16	32	23	3 NT	N 11	460	-9,0 9,0
8	1	15	3 NT	N 11	460	-9,0 9,0
6	3	13	3 NT	N 11	460	-9,0 9,0
5	12	4	4 Spar	S 11	450	-14,0 14,0
17	24	31	5 Spar	N 11	450	-14,0 14,0
1	40	8	3 NT	N 8	50	-18,0 18,0
4	5	11	3 NT	N 8	50	-18,0 18,0

SPILLSTENSILER

Kragerøcupen 2008, 23.-24. august 2008

Mappen: **25(25)**
Runden: **9**

Nord / ØV

♠ 9
♥ AKJT
♦ K4
♣ AQ6432

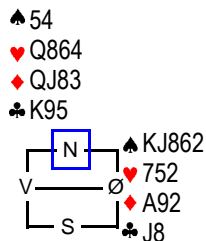

♠ AQT73
♥ 93
♦ T765
♣ T7

Bord	NS	ØV	NS	ØV	NS	ØV
9	17	1 6 NT	Ø 8	400	19,0	-19,0
13	36	21 3 NT	Ø 8	100	17,0	-17,0
8	2	16 3 Kløver	V 10	130	14,0	-14,0
12	37	20 4 Kløver	V 10	130	14,0	-14,0
7	3	15 2 Spar D	S 6	300	8,0	-8,0
1	40	9 2 Spar D	S 6	300	8,0	-8,0
11	19	38 2 Spar D	S 6	300	8,0	-8,0
17	25	32 2 Spar D	S 6	300	8,0	-8,0
15	34	23 2 Spar D	S 5	500	2,0	-2,0
6	4	14 2 Spar D	S 5	500	2,0	-2,0
14	22	35 3 NT	Ø 9	600	-7,0	7,0
16	33	24 3 NT	V 9	600	-7,0	7,0
18	26	31 3 NT	V 9	600	-7,0	7,0
19	27	30 3 NT	V 9	600	-7,0	7,0
4	6	12 3 NT	Ø 9	600	-7,0	7,0
3	7	11 3 NT	V 9	600	-7,0	7,0
2	8	10 3 NT	Ø 9	600	-7,0	7,0
20	29	28 3 NT	Ø 10	630	-17,0	17,0
5	13	5 3 NT	Ø 10	630	-17,0	17,0
10	39	18 3 NT	Ø 10	630	-17,0	17,0

Mappen: **26(26)**
Runden: **9**

Øst / Alle

♠ KQJ952
♥ 7
♦ 2
♣ KT742

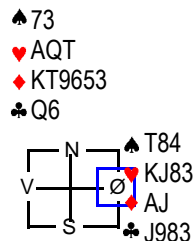

♠ A6
♥ 96542
♦ Q874
♣ A5

Bord	NS	ØV	NS	ØV	NS	ØV
4	6	12 4 Spar	V 9	100	19,0	-19,0
8	2	16 3 Ruter	N 8	100	17,0	-17,0
19	27	30 2 Spar	V 10	170	9,0	-9,0
2	8	10 2 Spar	V 10	170	9,0	-9,0
16	33	24 2 Spar	V 10	170	9,0	-9,0
1	40	9 2 Spar	Ø 10	170	9,0	-9,0
11	19	38 3 Spar	V 10	170	9,0	-9,0
18	26	31 3 Spar	V 10	170	9,0	-9,0
20	29	28 3 Spar	V 10	170	9,0	-9,0
9	17	1 4 Hjerter	V 10	620	-4,0	4,0
12	37	20 4 Spar	V 10	620	-4,0	4,0
13	36	21 4 Spar	V 10	620	-4,0	4,0
6	4	14 4 Spar	V 10	620	-4,0	4,0
3	7	11 4 Spar	V 10	620	-4,0	4,0
10	39	18 4 Spar	V 10	620	-4,0	4,0
14	22	35 4 Spar D	V 10	790	-12,0	12,0
17	25	32 4 Spar D	V 10	790	-12,0	12,0
5	13	5 5 Hjerter D	S 8	800	-15,0	15,0
7	3	15 3 Spar D	Ø 10	930	-17,0	17,0
15	34	23 5 Hjerter D	S 7	1100	-19,0	19,0

Mappen: **27(27)**
Runden: **9**

Syd / Ingen

♠ J93
♥ 643
♦ KJ32
♣ 973

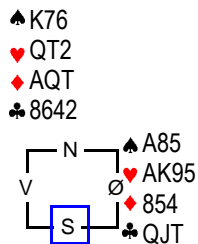

♠ QT42
♥ J87
♦ 976
♣ AK5

Bord	NS	ØV	NS	ØV	NS	ØV
11	19	38 1 NT	N 8	120	17,0	-17,0
4	6	12 1 NT	N 8	120	17,0	-17,0
7	3	15 1 NT	S 8	120	17,0	-17,0
19	27	30 1 Spar	N 8	110	8,0	-8,0
16	33	24 1 Spar	S 8	110	8,0	-8,0
15	34	23 1 Spar	S 8	110	8,0	-8,0
8	2	16 1 Spar	S 8	110	8,0	-8,0
9	17	1 2 Spar	N 8	110	8,0	-8,0
13	36	21 2 Spar	S 8	110	8,0	-8,0
14	22	35 1 NT	V 5	100	0,0	0,0
17	25	32 1 NT	Ø 5	100	0,0	0,0
6	4	14 1 NT	N 7	90	-4,0	4,0
2	8	10 1 NT	N 7	90	-4,0	4,0
18	26	31 1 Spar	S 7	80	-7,0	7,0
1	40	9 1 Hjerter	Ø 6	50	-14,0	14,0
12	37	20 1 NT	V 6	50	-14,0	14,0
20	29	28 1 NT	Ø 6	50	-14,0	14,0
3	7	11 1 NT	Ø 6	50	-14,0	14,0
10	39	18 1 NT	Ø 6	50	-14,0	14,0
5	13	5 1 Ruter	Ø 6	50	-14,0	14,0

Mappen: **28(28)**
Runden: **10**

Vest / N/S

♠ 8
♥ J984
♦ 974
♣ KT963

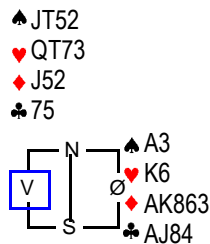

♠ KQ9764
♥ A52
♦ QT
♣ Q2

Bord	NS	ØV	NS	ØV	NS	ØV
8	3	17 3 NT	Ø 6	150	18,9	-18,9
14	23	36 3 Spar	S 9	140	16,8	-16,8
6	5	15 3 NT	Ø 8	50	12,6	-12,6
17	26	33 5 Kløver	Ø 10	50	12,6	-12,6
12	38	21 5 Kløver	Ø 10	50	12,6	-12,6
3	8	12 3 Spar	S 8	100	8,4	-8,4
1	40	10 60%-60%			3,8	3,8
2	9	11 3 Kløver	Ø 10	130	3,2	-3,2
11	20	39 4 Kløver	Ø 10	130	3,2	-3,2
15	35	24 4 Kløver	Ø 10	130	3,2	-3,2
7	4	16 4 Kløver	Ø 10	130	3,2	-3,2
5	14	6 3 Kløver	Ø 11	150	-3,2	3,2
16	34	25 4 Ruter	Ø 11	150	-3,2	3,2
19	28	31 2 NT	Ø 10	180	-6,3	6,3
10	1	19 3 Spar D	S 8	200	-8,4	8,4
20	30	29 3 NT	Ø 11	460	-13,7	13,7
4	7	13 3 NT	Ø 11	460	-13,7	13,7
13	37	22 3 NT	Ø 11	460	-13,7	13,7
9	18	2 3 NT	Ø 11	460	-13,7	13,7
18	27	32 3 Spar D	S 7	500	-18,9	18,9

SPILLSTENSILER

Kragerøcupen 2008, 23.-24. august 2008

Mappen: **29(29)**
Runden: **10**

Nord / Alle

♠ J875
♥ 876532
♦ 6
♣ K4

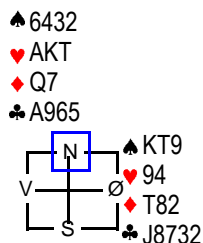

♠ AQ
♥ QJ
♦ AKJ9543
♣ QT

Bord	NS	ØV	NS	ØV	NS	ØV
11	20	39	7 NT	N 13	2220	17,0 -17,0
8	3	17	7 NT	N 13	2220	17,0 -17,0
10	1	19	7 NT	N 13	2220	17,0 -17,0
13	37	22	7 Ruter	S 13	2140	13,0 -13,0
1	40	10	6 NT	N 13	1470	1,0 -1,0
3	8	12	6 NT	N 13	1470	1,0 -1,0
4	7	13	6 NT	N 13	1470	1,0 -1,0
5	14	6	6 NT	N 13	1470	1,0 -1,0
6	5	15	6 NT	N 13	1470	1,0 -1,0
7	4	16	6 NT	N 13	1470	1,0 -1,0
9	18	2	6 NT	S 13	1470	1,0 -1,0
19	28	31	6 NT	N 13	1470	1,0 -1,0
17	26	33	6 NT	N 13	1470	1,0 -1,0
12	38	21	6 NT	N 13	1470	1,0 -1,0
14	23	36	6 NT	N 13	1470	1,0 -1,0
2	9	11	6 NT	N 12	1440	-11,0 11,0
15	35	24	6 Ruter	S 13	1390	-14,0 14,0
16	34	25	6 Ruter	S 13	1390	-14,0 14,0
18	27	32	6 Ruter	S 12	1370	-17,0 17,0
20	30	29	3 NT	N 13	720	-19,0 19,0

Mappen: **30(30)**
Runden: **10**

Øst / Ingen

♠ KT93
♥ AK9
♦ 86
♣ K762

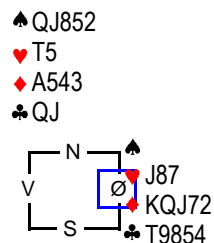

♠ A764
♥ Q6432
♦ T9
♣ A3

Bord	NS	ØV	NS	ØV	NS	ØV
16	34	25	2 Hjerter	S 7	50	19,0 -19,0
4	7	13	3 Spar	N 7	100	15,0 -15,0
5	14	6	3 Spar D	N 8	100	15,0 -15,0
15	35	24	4 Spar D	S 9	100	15,0 -15,0
8	3	17	2 Ruter	Ø 9	110	11,0 -11,0
18	27	32	2 Ruter	Ø 11	150	5,0 -5,0
11	20	39	3 Kløver	Ø 11	150	5,0 -5,0
19	28	31	3 Ruter	Ø 11	150	5,0 -5,0
3	8	12	3 Spar	N 6	150	5,0 -5,0
10	1	19	4 Kløver	V 11	150	5,0 -5,0
1	40	10	3 Spar D	N 7	300	-1,0 1,0
2	9	11	3 NT	Ø 9	400	-4,0 4,0
7	4	16	5 Kløver	V 11	400	-4,0 4,0
13	37	22	5 Kløver	V 12	420	-7,0 7,0
12	38	21	3 NT	V 10	430	-9,0 9,0
20	30	29	4 Spar D	N 7	500	-12,0 12,0
17	26	33	4 Spar D	N 7	500	-12,0 12,0
9	18	2	4 Kløver D	Ø 10	510	-15,0 15,0
14	23	36	5 Kløver D	V 11	550	-17,0 17,0
6	5	15	5 Spar D	N 6	1100	-19,0 19,0

Mappen: **31(31)**
Runden: **11**

Syd / N/S

♠ K964
♥ AJT
♦ A
♣ AKJ53

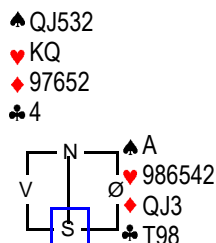

♠ T87
♥ 73
♦ KT84
♣ Q762

Bord	NS	ØV	NS	ØV	NS	ØV
8	4	18	6 Hjerter	Ø 11	50	18,9 -18,9
9	19	3	1 Spar D	N 6	200	16,7 -16,7
3	9	13	4 Hjerter	V 10	420	14,4 -14,4
19	29	32	3 NT	V 10	430	12,2 -12,2
15	36	25	4 Hjerter	V 11	450	7,8 -7,8
6	6	16	4 Hjerter	V 11	450	7,8 -7,8
20	31	30	5 Hjerter	Ø 11	450	7,8 -7,8
2	10	12	60%-60%			3,8 3,8
4	8	14	3 NT	V 11	460	2,2 -2,2
16	35	26	4 NT	Ø 11	460	2,2 -2,2
1	40	11	40%-60%			-3,8 3,8
7	5	17	4 Hjerter	V 12	480	-5,6 5,6
11	21	1	4 Hjerter	V 12	480	-5,6 5,6
12	39	22	4 Hjerter	V 12	480	-5,6 5,6
18	28	33	4 Hjerter	Ø 12	480	-5,6 5,6
17	27	34	5 Hjerter	Ø 12	480	-5,6 5,6
13	38	23	6 Hjerter	Ø 12	980	-15,6 15,6
5	15	7	6 Hjerter	V 12	980	-15,6 15,6
14	24	37	6 Hjerter	Ø 12	980	-15,6 15,6
10	2	20	6 Hjerter	Ø 12	980	-15,6 15,6

Mappen: **32(32)**
Runden: **11**

Vest / ØV

♠ 986542
♥ 75
♦ T8
♣ KQJ

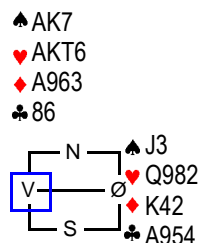

♠ QT
♥ J43
♦ QJ75
♣ T732

Bord	NS	ØV	NS	ØV	NS	ØV
16	35	26	3 NT	N 9	400	15,0 -15,0
15	36	25	3 NT	N 9	400	15,0 -15,0
13	38	23	3 NT	S 9	400	15,0 -15,0
8	4	18	3 NT	N 9	400	15,0 -15,0
7	5	17	3 NT	N 9	400	15,0 -15,0
3	9	13	1 NT	N 10	180	9,0 -9,0
1	40	11	1 NT	N 9	150	6,0 -6,0
12	39	22	2 NT	N 9	150	6,0 -6,0
4	8	14	1 Ruter	N 10	130	3,0 -3,0
11	21	1	1 NT	N 8	120	-2,0 2,0
19	29	32	2 NT	S 8	120	-2,0 2,0
2	10	12	2 NT	N 8	120	-2,0 2,0
14	24	37	2 NT	S 8	120	-2,0 2,0
17	27	34	3 Ruter	N 9	110	-7,0 7,0
5	15	7	3 NT	N 8	50	-14,0 14,0
6	6	16	3 NT	S 8	50	-14,0 14,0
10	2	20	3 NT	S 8	50	-14,0 14,0
20	31	30	3 NT	S 8	50	-14,0 14,0
18	28	33	3 NT	S 8	50	-14,0 14,0
9	19	3	3 NT	S 8	50	-14,0 14,0

SPILLSTENSILER

Kragerøcupen 2008, 23.-24. august 2008

Mappen: 1(33)

Runden: 11

Nord / Ingen

♠ AKJ972
♥ T
♦ Q
♣ K8742

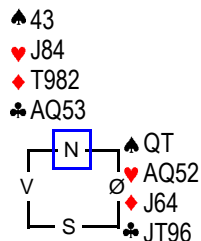

♠ 865
♥ K9763
♦ AK753
♣

Bord	NS	ØV	NS	ØV	NS	ØV
14	24	37	3 Hjerter D	S 9	530	19,0 -19,0
19	29	32	4 Spar	V 8	100	15,0 -15,0
2	10	12	4 Spar D	V 9	100	15,0 -15,0
4	8	14	4 Spar D	V 9	100	15,0 -15,0
10	2	20	4 Spar	V 9	50	3,0 -3,0
3	9	13	4 Spar	V 9	50	3,0 -3,0
6	6	16	4 Spar	V 9	50	3,0 -3,0
7	5	17	4 Spar	V 9	50	3,0 -3,0
1	40	11	4 Spar	V 9	50	3,0 -3,0
9	19	3	4 Spar	V 9	50	3,0 -3,0
20	31	30	4 Spar	V 9	50	3,0 -3,0
12	39	22	4 Spar	V 9	50	3,0 -3,0
17	27	34	4 Spar	V 9	50	3,0 -3,0
5	15	7	3 Ruter	S 7	100	-7,0 7,0
8	4	18	3 Spar	V 10	170	-9,0 9,0
13	38	23	4 Spar	V 10	420	-13,0 13,0
15	36	25	4 Spar	V 10	420	-13,0 13,0
18	28	33	4 Spar	V 10	420	-13,0 13,0
16	35	26	4 Kløver D	V 10	510	-17,0 17,0
11	21	1	3 Kløver D	V 11	670	-19,0 19,0

Mappen: 2(34)

Runden: 12

Øst / N/S

♠ T6
♥ AKT96
♦ KQJ94
♣ 5

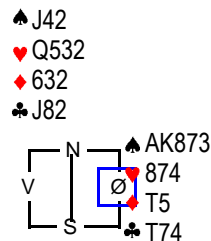

♠ Q95
♥ J
♦ A87
♣ AKQ963

Bord	NS	ØV	NS	ØV	NS	ØV
1	40	12	4 Hjerter	V 8	100	19,0 -19,0
2	11	13	3 Hjerter	V 8	50	16,0 -16,0
13	39	24	4 Hjerter	V 9	50	16,0 -16,0
12	1	23	3 NT	N 8	100	13,0 -13,0
17	28	35	3 Ruter	V 10	130	11,0 -11,0
8	5	19	2 Hjerter	V 9	140	9,0 -9,0
10	3	21	2 Hjerter	V 10	170	2,0 -2,0
15	37	26	2 Hjerter	V 10	170	2,0 -2,0
16	36	27	3 Hjerter	V 10	170	2,0 -2,0
20	32	31	3 Hjerter	Ø 10	170	2,0 -2,0
5	16	8	3 Hjerter	V 10	170	2,0 -2,0
3	10	14	3 Spar	Ø 10	170	2,0 -2,0
14	25	38	3 Kløver D	S 8	200	-8,0 8,0
6	7	17	3 NT	S 7	200	-8,0 8,0
9	20	4	3 NT	S 7	200	-8,0 8,0
18	29	34	4 Hjerter	S 8	200	-8,0 8,0
7	6	18	4 Hjerter	V 10	420	-16,0 16,0
4	9	15	4 Hjerter	V 10	420	-16,0 16,0
19	30	33	4 Hjerter	V 10	420	-16,0 16,0
11	22	2	4 Hjerter	Ø 10	420	-16,0 16,0

Mappen: 3(35)

Runden: 12

Syd / ØV

♠ KQ432
♥ T64
♦ T2
♣ J83

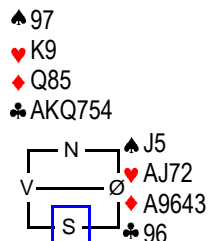

♠ AT86
♥ Q853
♦ KJ7
♣ T2

Bord	NS	ØV	NS	ØV	NS	ØV
9	20	4	3 NT	N 11	460	19,0 -19,0
2	11	13	3 NT	N 10	430	8,0 -8,0
3	10	14	3 NT	N 10	430	8,0 -8,0
5	16	8	3 NT	N 10	430	8,0 -8,0
8	5	19	3 NT	N 10	430	8,0 -8,0
11	22	2	3 NT	N 10	430	8,0 -8,0
12	1	23	3 NT	N 10	430	8,0 -8,0
14	25	38	3 NT	N 10	430	8,0 -8,0
15	37	26	3 NT	N 10	430	8,0 -8,0
17	28	35	3 NT	N 10	430	8,0 -8,0
10	3	21	3 NT	N 10	430	8,0 -8,0
13	39	24	3 NT	S 9	400	-7,0 7,0
20	32	31	3 NT	S 9	400	-7,0 7,0
7	6	18	3 NT	S 9	400	-7,0 7,0
18	29	34	3 NT	N 9	400	-7,0 7,0
19	30	33	3 NT	S 9	400	-7,0 7,0
4	9	15	2 Spar D	V 7	200	-13,0 13,0
1	40	12	2 Kløver	N 10	130	-17,0 17,0
16	36	27	2 Kløver	S 10	130	-17,0 17,0
6	7	17	3 Kløver	N 10	130	-17,0 17,0

Mappen: 4(36)

Runden: 12

Vest / Alle

♠ K32
♥ KJ986
♦ AK52
♣ 9

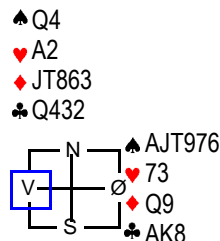

♠ 85
♥ QT54
♦ 74
♣ JT765

Bord	NS	ØV	NS	ØV	NS	ØV
7	6	18	2 Spar	Ø 12	230	19,0 -19,0
10	3	21	3 NT	Ø 10	630	16,0 -16,0
4	9	15	3 NT	Ø 10	630	16,0 -16,0
18	29	34	3 NT	Ø 11	660	9,0 -9,0
15	37	26	3 NT	Ø 11	660	9,0 -9,0
13	39	24	3 NT	Ø 11	660	9,0 -9,0
6	7	17	3 NT	Ø 11	660	9,0 -9,0
8	5	19	3 NT	Ø 11	660	9,0 -9,0
2	11	13	4 Spar	Ø 12	680	-8,0 8,0
3	10	14	4 Spar	Ø 12	680	-8,0 8,0
5	16	8	4 Spar	Ø 12	680	-8,0 8,0
1	40	12	4 Spar	Ø 12	680	-8,0 8,0
9	20	4	4 Spar	Ø 12	680	-8,0 8,0
20	32	31	4 Spar	Ø 12	680	-8,0 8,0
12	1	23	4 Spar	Ø 12	680	-8,0 8,0
14	25	38	4 Spar	Ø 12	680	-8,0 8,0
16	36	27	4 Spar	Ø 12	680	-8,0 8,0
17	28	35	4 Spar	Ø 12	680	-8,0 8,0
19	30	33	4 Spar	Ø 12	680	-8,0 8,0
11	22	2	5 Spar	Ø 12	680	-8,0 8,0

SPILLSTENSILER

Kragerøcupen 2008, 23.-24. august 2008

Mappnr: 5(37)

Rundenr: 13

Nord / N/S

- ♠ J8653
- ♥ A76
- ♦ QT4
- ♣ J4

- ♠ AT92
- ♥ KJ92
- ♦ A63
- ♣ T7

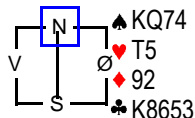

- ♠ Q843
- ♥ KJ875
- ♦ AQ92

Bord	NS	ØV	NS	ØV	NS	ØV
9	21	5 4 Spar D	Ø 6	800	18,9	-18,9
3	11	15 4 Hjerter	S 12	680	15,8	-15,8
13	1	25 4 Hjerter	N 12	680	15,8	-15,8
4	10	16 4 Hjerter	N 11	650	6,3	-6,3
8	6	20 4 Hjerter	N 11	650	6,3	-6,3
11	23	3 4 Hjerter	S 11	650	6,3	-6,3
17	29	36 4 Hjerter	N 11	650	6,3	-6,3
7	7	19 5 Hjerter	N 11	650	6,3	-6,3
6	8	18 5 Hjerter	S 11	650	6,3	-6,3
19	31	34 5 Hjerter	N 11	650	6,3	-6,3
12	2	24 40%-60%			-3,8	3,8
16	37	28 4 Hjerter	S 10	620	-4,2	4,2
5	17	9 4 Hjerter	N 10	620	-4,2	4,2
18	30	35 4 Hjerter	N 10	620	-4,2	4,2
15	38	27 3 NT	N 9	600	-10,5	10,5
10	22	4 3 NT	N 9	600	-10,5	10,5
20	33	32 5 Ruter	N 11	600	-10,5	10,5
1	40	13 3 NT	N 8	100	-15,8	15,8
2	12	14 4 Hjerter	N 9	100	-15,8	15,8
14	26	39 6 Hjerter	N 10	200	-18,9	18,9

Mappnr: 6(38)

Rundenr: 13

Øst / Ø/V

- ♠ KQ754
- ♥ 87
- ♦ T53
- ♣ 942

- ♠ J82
- ♥ J65
- ♦ K92
- ♣ QJ53

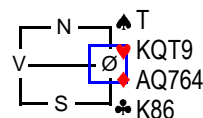

- ♠ A963
- ♥ A432
- ♦ J8
- ♣ AT7

Bord	NS	ØV	NS	ØV	NS	ØV
17	29	36 2 Spar	V 5	300	19,0	-19,0
14	26	39 2 Spar	V 6	200	17,0	-17,0
6	8	18 2 Ruter	Ø 7	100	15,0	-15,0
11	23	3 1 NT	N 7	90	11,0	-11,0
3	11	15 1 NT	N 7	90	11,0	-11,0
5	17	9 1 NT	N 7	90	11,0	-11,0
4	10	16 1 NT	N 6	50	2,0	-2,0
1	40	13 1 NT	N 6	50	2,0	-2,0
10	4	22 1 NT	N 6	50	2,0	-2,0
12	2	24 1 NT	N 6	50	2,0	-2,0
13	1	25 1 NT	N 6	50	2,0	-2,0
16	37	28 1 NT	N 6	50	2,0	-2,0
7	7	19 1 NT	Ø 7	90	-8,0	8,0
20	33	32 2 Ruter	Ø 8	90	-8,0	8,0
15	38	27 2 Ruter	Ø 8	90	-8,0	8,0
19	31	34 2 Ruter	Ø 8	90	-8,0	8,0
18	30	35 2 Ruter	Ø 9	110	-14,0	14,0
8	6	20 2 Spar	V 8	110	-14,0	14,0
2	12	14 1 NT	Ø 8	120	-18,0	18,0
9	21	5 1 NT	Ø 8	120	-18,0	18,0

Mappnr: 7(39)

Rundenr: 13

Syd / Alle

- ♠ T98
- ♥ Q75
- ♦ JT3
- ♣ AQT7

- ♠ AKJ2
- ♥ J
- ♦ K98762
- ♣ K3

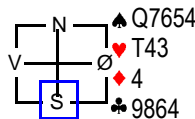

- ♠ 3
- ♥ AK9862
- ♦ AQ5
- ♣ J52

Bord	NS	ØV	NS	ØV	NS	ØV
10	4	22 6 NT	N 12	1440	19,0	-19,0
12	2	24 6 Ruter	N 12	1370	14,0	-14,0
20	33	32 6 Ruter	N 12	1370	14,0	-14,0
5	17	9 6 Ruter	N 12	1370	14,0	-14,0
6	8	18 6 Ruter	N 12	1370	14,0	-14,0
3	11	15 3 NT	N 12	690	8,0	-8,0
14	26	39 3 NT	N 12	690	8,0	-8,0
19	31	34 3 NT	N 11	660	1,0	-1,0
18	30	35 3 NT	N 11	660	1,0	-1,0
17	29	36 3 NT	N 11	660	1,0	-1,0
4	10	16 3 NT	N 11	660	1,0	-1,0
13	1	25 3 NT	N 11	660	1,0	-1,0
1	40	13 4 Hjerter	S 11	650	-8,0	8,0
11	23	3 4 Hjerter	S 11	650	-8,0	8,0
16	37	28 4 Hjerter	S 11	650	-8,0	8,0
15	38	27 5 Hjerter	S 11	650	-8,0	8,0
9	21	5 3 NT	N 10	630	-13,0	13,0
2	12	14 5 Ruter	N 11	600	-15,0	15,0
8	6	20 4 Ruter	N 11	150	-17,0	17,0
7	7	19 6 Ruter	N 11	100	-19,0	19,0

Mappnr: 8(40)

Rundenr: 14

Vest / Ingen

- ♠ QJT95
- ♥ 83
- ♦ AK86
- ♣ A6

- ♠ K6
- ♥ AKQT65
- ♦ J
- ♣ KQ43

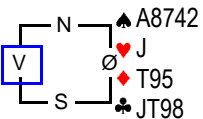

- ♠ 3
- ♥ 9742
- ♦ Q7432
- ♣ 752

Bord	NS	ØV	NS	ØV	NS	ØV
18	31	36 5 Hjerter	N 10	50	16,0	-16,0
17	30	37 5 Hjerter	N 10	50	16,0	-16,0
4	11	17 5 Hjerter	N 10	50	16,0	-16,0
6	9	19 5 Hjerter	N 10	50	16,0	-16,0
10	5	23 5 Hjerter D	N 10	100	4,0	-4,0
2	13	15 5 Hjerter D	S 10	100	4,0	-4,0
7	8	20 5 Hjerter D	N 10	100	4,0	-4,0
8	7	21 5 Hjerter D	N 10	100	4,0	-4,0
1	40	14 5 Hjerter D	N 10	100	4,0	-4,0
9	22	6 5 Hjerter D	N 10	100	4,0	-4,0
16	38	29 5 Hjerter D	N 10	100	4,0	-4,0
19	32	35 5 Hjerter D	N 10	100	4,0	-4,0
20	34	33 4 Spar	V 10	420	-8,0	8,0
15	39	28 4 Spar	V 10	420	-8,0	8,0
5	18	10 4 Spar	V 10	420	-8,0	8,0
3	12	16 4 Spar	V 10	420	-8,0	8,0
13	2	26 4 Spar	V 11	450	-14,0	14,0
14	27	1 4 Spar	V 11	450	-14,0	14,0
11	24	4 4 Spar D	V 10	590	-17,0	17,0
12	3	25 5 Spar D	V 11	650	-19,0	19,0

SPILLSTENSILER

Kragerøcupen 2008, 23.-24. august 2008

Mappen: 9(41)

Runden: 14

Nord / ØV

♠ KQ862
♥ A83
♦ 752
♣ A9

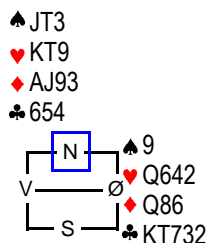

♠ A754
♥ J75
♦ KT4
♣ QJ8

Bord	NS	ØV	NS	ØV	NS	ØV
15	39	28	1 NT	Ø 6	100	18,0 -18,0
16	38	29	2 Spar	V 7	100	18,0 -18,0
10	5	23	1 NT	N 7	90	11,0 -11,0
7	8	20	1 NT	N 7	90	11,0 -11,0
1	40	14	1 NT	N 7	90	11,0 -11,0
9	22	6	1 NT	N 7	90	11,0 -11,0
13	2	26	1 NT	S 7	90	11,0 -11,0
17	30	37	1 NT	N 6	50	3,0 -3,0
8	7	21	1 NT	N 6	50	3,0 -3,0
5	18	10	1 NT	S 6	50	3,0 -3,0
18	31	36	1 Spar	V 7	80	-2,0 2,0
4	11	17	1 Spar	V 7	80	-2,0 2,0
6	9	19	1 NT	Ø 7	90	-8,0 8,0
3	12	16	1 NT	Ø 7	90	-8,0 8,0
2	13	15	1 NT	Ø 7	90	-8,0 8,0
11	24	4	1 NT	Ø 7	90	-8,0 8,0
20	34	33	1 NT	Ø 8	120	-13,0 13,0
14	27	1	1 NT	N 4	150	-16,0 16,0
12	3	25	2 Spar	S 5	150	-16,0 16,0
19	32	35	1 NT	N 3	200	-19,0 19,0

Mappen: 10(42)

Runden: 14

Øst / Alle

♠ A974
♥ T9432
♦
♣ A932

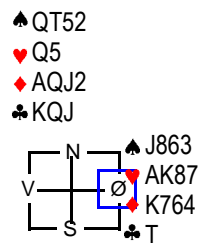

♠ K
♥ J6
♦ T9853
♣ 87654

Bord	NS	ØV	NS	ØV	NS	ØV
3	12	16	4 Spar	Ø 8	200	19,0 -19,0
8	7	21	3 Hjerter	V 10	170	17,0 -17,0
18	31	36	2 Hjerter	V 12	230	14,0 -14,0
15	39	28	2 Hjerter	V 12	230	14,0 -14,0
9	22	6	3 Ruter	S 6	300	10,0 -10,0
16	38	29	3 Ruter	S 6	300	10,0 -10,0
12	3	25	3 Kløver D	S 7	500	6,0 -6,0
20	34	33	3 Kløver D	S 7	500	6,0 -6,0
19	32	35	4 Hjerter	V 10	620	3,0 -3,0
17	30	37	4 Hjerter	V 11	650	-3,0 3,0
4	11	17	4 Hjerter	V 11	650	-3,0 3,0
5	18	10	4 Hjerter	Ø 11	650	-3,0 3,0
7	8	20	4 Hjerter	V 11	650	-3,0 3,0
6	9	19	4 Hjerter	Ø 11	650	-3,0 3,0
2	13	15	4 Hjerter	V 12	680	-11,0 11,0
10	5	23	4 Hjerter	V 12	680	-11,0 11,0
14	27	1	4 Hjerter	V 12	680	-11,0 11,0
13	2	26	4 Hjerter D	V 10	790	-15,0 15,0
11	24	4	4 Hjerter D	Ø 11	990	-17,0 17,0
1	40	14	5 Ruter D	S 6	1400	-19,0 19,0

Mappen: 11(43)

Runden: 15

Syd / Ingen

♠ 952
♥ T98
♦ J873
♣ Q53

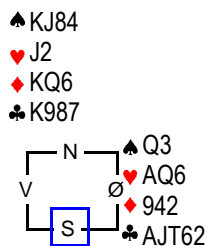

♠ AT76
♥ K7543
♦ AT5
♣ 4

Bord	NS	ØV	NS	ØV	NS	ØV
9	23	7	4 Spar	N 11	450	14,0 -14,0
19	33	36	4 Spar	N 11	450	14,0 -14,0
18	32	37	4 Spar	N 11	450	14,0 -14,0
3	13	17	4 Spar	N 11	450	14,0 -14,0
5	19	11	4 Spar	N 11	450	14,0 -14,0
7	9	21	4 Spar	N 11	450	14,0 -14,0
4	12	18	4 Spar	N 10	420	-1,0 1,0
6	10	20	4 Spar	N 10	420	-1,0 1,0
8	8	22	4 Spar	N 10	420	-1,0 1,0
1	40	15	4 Spar	N 10	420	-1,0 1,0
11	25	5	4 Spar	N 10	420	-1,0 1,0
20	35	34	4 Spar	N 10	420	-1,0 1,0
14	28	2	4 Spar	N 10	420	-1,0 1,0
17	31	38	4 Spar	N 10	420	-1,0 1,0
10	6	24	4 Spar	N 10	420	-1,0 1,0
15	1	29	2 Spar	N 11	200	-11,0 11,0
13	3	27	3 NT	N 8	50	-14,0 14,0
2	14	16	4 Spar	N 9	50	-14,0 14,0
16	39	30	3 NT	N 7	100	-18,0 18,0
12	4	26	4 Spar	N 8	100	-18,0 18,0

Mappen: 12(44)

Runden: 15

Vest / N/S

♠ AKT5
♥ AK4
♦ 95
♣ AKJ7

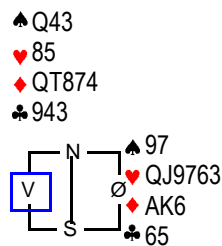

♠ J862
♥ T2
♦ J32
♣ QT82

Bord	NS	ØV	NS	ØV	NS	ØV
9	23	7	4 Hjerter	V 13	510	19,0 -19,0
20	35	34	6 NT	V 12	990	17,0 -17,0
4	12	18	6 Hjerter	Ø 13	1010	7,0 -7,0
7	9	21	6 Hjerter	Ø 13	1010	7,0 -7,0
1	40	15	6 Hjerter	Ø 13	1010	7,0 -7,0
10	6	24	6 Hjerter	Ø 13	1010	7,0 -7,0
12	4	26	6 Hjerter	V 13	1010	7,0 -7,0
13	3	27	6 Hjerter	Ø 13	1010	7,0 -7,0
15	1	29	6 Hjerter	Ø 13	1010	7,0 -7,0
16	39	30	6 Hjerter	V 13	1010	7,0 -7,0
18	32	37	6 Hjerter	Ø 13	1010	7,0 -7,0
8	8	22	6 NT	Ø 13	1020	-5,0 5,0
6	10	20	6 NT	V 13	1020	-5,0 5,0
5	19	11	6 NT	Ø 13	1020	-5,0 5,0
14	28	2	7 Hjerter	Ø 13	1510	-10,0 10,0
17	31	38	7 Hjerter	Ø 13	1510	-10,0 10,0
19	33	36	7 NT	Ø 13	1520	-16,0 16,0
3	13	17	7 NT	V 13	1520	-16,0 16,0
2	14	16	7 NT	Ø 13	1520	-16,0 16,0
11	25	5	7 NT	V 13	1520	-16,0 16,0

SPILLSTENSILER

Kragerøcupen 2008, 23.-24. august 2008

Mappnr: 13(45)

Runden: 15

Nord / Alle

♠ AKT74
♥ AQ97
♦ 6
♣ Q74

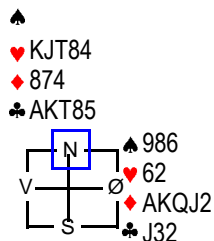

♠ QJ532
♥ 53
♦ T953
♣ 96

Bord	NS	ØV	NS	ØV	NS	ØV
18	32	37	3 Spar D	V 7	500	19,0 -19,0
7	9	21	3 Spar D	V 8	200	13,0 -13,0
11	25	5	4 Spar D	V 9	200	13,0 -13,0
5	19	11	4 Spar D	V 9	200	13,0 -13,0
1	40	15	4 Spar D	V 9	200	13,0 -13,0
10	6	24	4 Spar D	V 9	200	13,0 -13,0
6	10	20	3 NT	V 8	100	2,0 -2,0
12	4	26	4 Spar	V 9	100	2,0 -2,0
16	39	30	4 Spar	V 9	100	2,0 -2,0
17	31	38	4 Spar	V 9	100	2,0 -2,0
4	12	18	4 Spar	V 9	100	2,0 -2,0
2	14	16	4 Spar	V 9	100	2,0 -2,0
15	1	29	2 Hjerter	N 7	100	-5,0 5,0
20	35	34	3 NT	V 9	600	-8,0 8,0
8	8	22	3 NT	V 9	600	-8,0 8,0
3	13	17	3 NT	V 10	630	-12,0 12,0
9	23	7	3 NT	V 10	630	-12,0 12,0
14	28	2	3 NT	V 11	660	-16,0 16,0
19	33	36	3 NT	V 11	660	-16,0 16,0
13	3	27	3 Spar D	V 9	730	-19,0 19,0

Mappnr: 14(46)

Runden: 16

Øst / Ingen

♠ Q95
♥ K975
♦ 643
♣ KT2

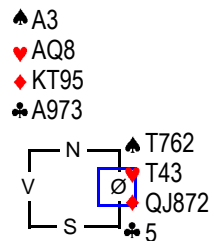

♠ KJ84
♥ J62
♦ A
♣ QJ864

Bord	NS	ØV	NS	ØV	NS	ØV
8	9	23	6 NT	N 12	990	19,0 -19,0
17	32	39	6 Kløver	S 12	920	15,0 -15,0
13	4	28	6 Kløver	S 12	920	15,0 -15,0
7	10	22	6 Kløver	S 12	920	15,0 -15,0
12	5	27	3 NT	N 12	490	11,0 -11,0
10	7	25	3 NT	S 11	460	2,0 -2,0
18	33	38	3 NT	N 11	460	2,0 -2,0
3	14	18	3 NT	N 11	460	2,0 -2,0
15	2	30	3 NT	N 11	460	2,0 -2,0
14	29	3	3 NT	S 11	460	2,0 -2,0
5	20	12	3 NT	S 11	460	2,0 -2,0
1	40	16	3 NT	N 11	460	2,0 -2,0
6	11	21	3 NT	N 11	460	2,0 -2,0
2	15	17	3 NT	N 10	430	-10,0 10,0
4	13	19	3 NT	N 10	430	-10,0 10,0
9	24	8	3 NT	N 10	430	-10,0 10,0
20	36	35	3 NT	N 10	430	-10,0 10,0
16	1	31	3 NT	N 9	400	-15,0 15,0
19	34	37	6 NT	N 11	50	-17,0 17,0
11	26	6	6 NT	N 10	100	-19,0 19,0

Mappnr: 15(47)

Runden: 16

Syd / N/S

♠ T5
♥ AK43
♦ A65
♣ T865

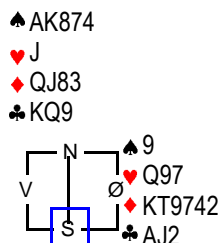

♠ QJ632
♥ T8652
♦ 743
♣ 743

Bord	NS	ØV	NS	ØV	NS	ØV
19	34	37	2 Spar D	N 11	1270	19,0 -19,0
15	2	30	4 Spar D	N 11	990	17,0 -17,0
6	11	21	5 Spar D	N 11	850	15,0 -15,0
11	26	6	4 Spar D	N 10	790	10,0 -10,0
4	13	19	4 Spar D	N 10	790	10,0 -10,0
7	10	22	4 Spar D	N 10	790	10,0 -10,0
14	29	3	4 Spar D	N 10	790	10,0 -10,0
12	5	27	4 Spar	N 11	650	5,0 -5,0
8	9	23	4 Spar	N 10	620	0,0 0,0
9	24	8	4 Spar	N 10	620	0,0 0,0
13	4	28	4 Spar	N 10	620	0,0 0,0
17	32	39	4 Spar	N 10	620	0,0 0,0
20	36	35	5 Ruter D	Ø 9	300	-5,0 5,0
10	7	25	4 Kløver	V 8	100	-9,0 9,0
3	14	18	5 Ruter D	Ø 10	100	-9,0 9,0
2	15	17	5 Ruter D	V 10	100	-9,0 9,0
1	40	16	4 Spar	N 9	100	-14,0 14,0
5	20	12	5 Spar	N 10	100	-14,0 14,0
18	33	38	3 Ruter	Ø 9	110	-17,0 17,0
16	1	31	4 Spar D	N 9	200	-19,0 19,0

Mappnr: 16(48)

Runden: 16

Vest / Ø/V

♠ KJ92
♥ J542
♦ J76
♣ Q8

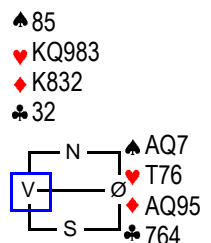

♠ T643
♥ A
♦ T4
♣ AKJT95

Bord	NS	ØV	NS	ØV	NS	ØV
15	2	30	3 Ruter	Ø 6	300	19,0 -19,0
10	7	25	2 Kløver	Ø 6	200	16,0 -16,0
6	11	21	3 Spar	V 7	200	16,0 -16,0
17	32	39	2 Hjerter	S 9	140	13,0 -13,0
3	14	18	2 Hjerter	N 8	110	7,0 -7,0
16	1	31	2 Hjerter	S 8	110	7,0 -7,0
5	20	12	3 Kløver	S 9	110	7,0 -7,0
13	4	28	3 Kløver	S 9	110	7,0 -7,0
12	5	27	3 Kløver	S 9	110	7,0 -7,0
4	13	19	2 Spar	Ø 7	100	1,0 -1,0
1	40	16	2 Kløver	S 8	90	-2,0 2,0
11	26	6	2 Kløver	S 8	90	-2,0 2,0
8	9	23	2 Hjerter	N 7	50	-7,0 7,0
20	36	35	3 Kløver	S 8	50	-7,0 7,0
19	34	37	3 NT	S 8	50	-7,0 7,0
14	29	3	3 Kløver	S 7	100	-13,0 13,0
18	33	38	3 Kløver	S 7	100	-13,0 13,0
2	15	17	3 Kløver	S 7	100	-13,0 13,0
7	10	22	2 Hjerter	N 5	150	-18,0 18,0
9	24	8	3 NT	N 6	150	-18,0 18,0

SPILLSTENSILER

Kragerøcupen 2008, 23.-24. august 2008

Mappnr: 17(49)

Runden: 17

Nord / Ingen

♠ A94
♥ 74
♦ T876
♣ J762

♠ Q853

♥ T6

♦ J95

♣ K984

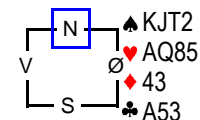

♠ 76
♥ KJ932
♦ AKQ2
♣ QT

Bord	NS	ØV	NS	ØV	NS	ØV
10	8	26	1 NT D	V 5	300	18,0 -18,0
20	37	36	2 Hjerter D	Ø 6	300	18,0 -18,0
5	21	13	2 Hjerter	S 10	170	15,0 -15,0
8	10	24	2 Hjerter	N 9	140	11,0 -11,0
11	27	7	2 Hjerter	S 9	140	11,0 -11,0
17	33	1	2 Hjerter	N 9	140	11,0 -11,0
13	5	29	1 NT	S 8	120	6,0 -6,0
9	25	9	1 NT	S 8	120	6,0 -6,0
14	30	4	2 Hjerter	S 8	110	-1,0 1,0
12	6	28	2 Hjerter	S 8	110	-1,0 1,0
18	34	39	2 Hjerter	S 8	110	-1,0 1,0
7	11	23	2 Hjerter	S 8	110	-1,0 1,0
6	12	22	2 Ruter	S 9	110	-1,0 1,0
3	15	19	1 Hjerter	Ø 5	100	-7,0 7,0
4	14	20	2 Ruter	S 8	90	-9,0 9,0
15	3	31	1 Hjerter	Ø 6	50	-14,0 14,0
16	2	32	1 Hjerter	Ø 6	50	-14,0 14,0
1	40	17	1 NT	V 6	50	-14,0 14,0
19	35	38	3 Kløver	Ø 8	50	-14,0 14,0
2	16	18	2 Hjerter	S 7	50	-19,0 19,0

Mappnr: 18(50)

Runden: 17

Øst / N/S

♠ J96
♥ A976
♦ T9
♣ KJ74

♠ Q5

♥ T42

♦ AK62

♣ AQT3

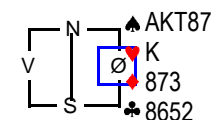

♠ 432
♥ QJ853
♦ QJ54
♣ 9

Bord	NS	ØV	NS	ØV	NS	ØV
2	16	18	2 Hjerter	N 9	140	18,0 -18,0
10	8	26	3 Hjerter	N 9	140	18,0 -18,0
8	10	24	2 Hjerter	N 8	110	12,0 -12,0
11	27	7	2 Hjerter	N 8	110	12,0 -12,0
13	5	29	2 Hjerter	N 8	110	12,0 -12,0
16	2	32	2 Hjerter	N 8	110	12,0 -12,0
20	37	36	3 Spar D	Ø 8	100	5,0 -5,0
1	40	17	3 Spar D	V 8	100	5,0 -5,0
19	35	38	3 Spar	V 7	100	5,0 -5,0
17	33	1	2 Spar	Ø 7	50	0,0 0,0
3	15	19	3 Spar	Ø 8	50	0,0 0,0
14	30	4	3 Hjerter	S 8	100	-5,0 5,0
5	21	13	3 Hjerter	S 8	100	-5,0 5,0
4	14	20	3 Hjerter	S 8	100	-5,0 5,0
15	3	31	2 Spar	V 8	110	-10,0 10,0
6	12	22	2 Spar	Ø 8	110	-10,0 10,0
18	34	39	2 Spar	Ø 9	140	-13,0 13,0
12	6	28	3 Hjerter D	S 8	200	-17,0 17,0
7	11	23	3 Hjerter	S 7	200	-17,0 17,0
9	25	9	3 Hjerter	S 7	200	-17,0 17,0

Mappnr: 19(51)

Runden: 17

Syd / ØV

♠ K63
♥ A72
♦ K32
♣ JT63

♠ 92

♥ T9653

♦ Q6

♣ Q987

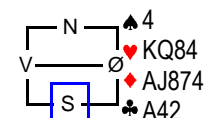

♠ AQJT875
♥ J
♦ T95
♣ K5

Bord	NS	ØV	NS	ØV	NS	ØV
10	8	26	3 Spar D	S 9	530	19,0 -19,0
4	14	20	6 NT	V 10	200	17,0 -17,0
6	12	22	4 Hjerter	V 9	100	15,0 -15,0
2	16	18	4 Spar	S 8	100	13,0 -13,0
18	34	39	3 Ruter	Ø 10	130	11,0 -11,0
3	15	19	3 Ruter	Ø 11	150	9,0 -9,0
8	10	24	2 NT	V 10	180	7,0 -7,0
19	35	38	3 Spar D	N 7	300	2,0 -2,0
7	11	23	3 Spar D	S 7	300	2,0 -2,0
5	21	13	4 Spar D	S 8	300	2,0 -2,0
20	37	36	4 Spar D	S 8	300	2,0 -2,0
14	30	4	4 Spar D	S 7	500	-3,0 3,0
17	33	1	3 NT	V 9	600	-5,0 5,0
1	40	17	3 NT	V 10	630	-13,0 13,0
11	27	7	3 NT	V 10	630	-13,0 13,0
12	6	28	3 NT	V 10	630	-13,0 13,0
13	5	29	3 NT	V 10	630	-13,0 13,0
15	3	31	3 NT	V 10	630	-13,0 13,0
16	2	32	3 NT	V 10	630	-13,0 13,0
9	25	9	3 NT	V 10	630	-13,0 13,0

Mappnr: 20(52)

Runden: 18

Vest / Alle

♠ KQT2
♥ T7
♦ AKQ83
♣ KT

♠ AJ9653

♥ AQJ62

♦

♣ 95

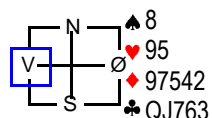

♠ 74
♥ K843
♦ JT6
♣ A842

Bord	NS	ØV	NS	ØV	NS	ØV
1	40	18	4 Hjerter D	N 12	1190	18,9 -18,9
9	26	10	5 Kløver D	Ø 7	1100	16,8 -16,8
5	22	14	4 Hjerter D	N 11	990	14,7 -14,7
12	7	29	5 Hjerter D	N 11	850	12,6 -12,6
11	28	8	4 Hjerter	N 12	680	8,4 -8,4
20	38	37	4 Hjerter	S 12	680	8,4 -8,4
18	35	1	4 Hjerter	N 12	680	8,4 -8,4
2	17	19	60%-60%			3,8 3,8
16	3	33	4 Hjerter	N 11	650	1,1 -1,1
3	16	20	4 Hjerter	S 11	650	1,1 -1,1
10	9	27	4 Hjerter	S 11	650	1,1 -1,1
6	13	23	5 Hjerter	S 11	650	1,1 -1,1
13	6	30	4 Hjerter	N 10	620	-5,3 5,3
17	34	2	4 Hjerter	N 10	620	-5,3 5,3
15	4	32	5 Ruter D	V 9	500	-10,5 10,5
8	11	25	5 Ruter D	V 9	500	-10,5 10,5
19	36	39	5 Ruter D	V 9	500	-10,5 10,5
7	12	24	2 Hjerter	S 12	230	-14,7 14,7
14	31	5	6 Hjerter	S 11	100	-16,8 16,8
4	15	21	5 Hjerter D	S 9	500	-18,9 18,9

SPILLSTENSILER

Kragerøcupen 2008, 23.-24. august 2008

Mappnr: 21(53)

Rundenr: 18

Nord / N/S

♠ J652
♥ AK
♦ A987
♣ K87

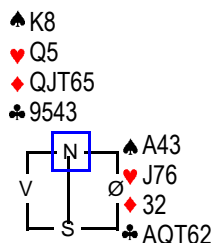

♠ QT97
♥ T98432
♦ K4
♣ J

Bord	NS	ØV		NS	ØV	NS	ØV
9	26	10	4 Spar	Ø 8	100	19,0	-19,0
1	40	18	3 Spar	V 8	50	17,0	-17,0
17	34	2	4 Spar	Ø 10	420	15,0	-15,0
2	17	19	3 NT	Ø 10	430	6,0	-6,0
3	16	20	3 NT	Ø 10	430	6,0	-6,0
7	12	24	3 NT	V 10	430	6,0	-6,0
8	11	25	3 NT	V 10	430	6,0	-6,0
11	28	8	3 NT	V 10	430	6,0	-6,0
20	38	37	3 NT	Ø 10	430	6,0	-6,0
18	35	1	3 NT	V 10	430	6,0	-6,0
10	9	27	3 NT	V 10	430	6,0	-6,0
12	7	29	3 NT	Ø 11	460	-10,0	10,0
14	31	5	3 NT	V 11	460	-10,0	10,0
15	4	32	3 NT	V 11	460	-10,0	10,0
16	3	33	3 NT	V 11	460	-10,0	10,0
6	13	23	3 NT	Ø 11	460	-10,0	10,0
5	22	14	3 NT	V 11	460	-10,0	10,0
4	15	21	3 NT	Ø 11	460	-10,0	10,0
19	36	39	3 NT	Ø 11	460	-10,0	10,0
13	6	30	3 NT	Ø 12	490	-19,0	19,0

Mappnr: 22(54)

Rundenr: 18

Øst / Ø/V

♠ KQJ97
♥ 2
♦ Q95
♣ Q952

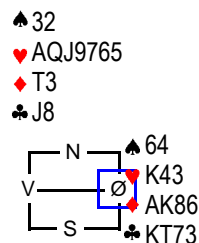

♠ AT85
♥ T8
♦ J742
♣ A64

Bord	NS	ØV		NS	ØV	NS	ØV
13	6	30	5 Kløver D	Ø 9	500	19,0	-19,0
8	11	25	2 Hjerter D	N 8	470	17,0	-17,0
12	7	29	4 Spar D	V 9	200	15,0	-15,0
1	40	18	3 Hjerter	N 9	140	13,0	-13,0
2	17	19	4 Kløver	Ø 9	100	8,0	-8,0
10	9	27	4 Spar	V 9	100	8,0	-8,0
7	12	24	4 Spar	V 9	100	8,0	-8,0
9	26	10	4 Spar	V 9	100	8,0	-8,0
16	3	33	3 Hjerter D	N 8	100	1,0	-1,0
6	13	23	3 Hjerter D	N 8	100	1,0	-1,0
18	35	1	4 Hjerter D	N 9	100	1,0	-1,0
3	16	20	3 Spar	V 9	140	-3,0	3,0
11	28	8	3 Spar	V 10	170	-5,0	5,0
17	34	2	4 Hjerter D	N 8	300	-8,0	8,0
19	36	39	4 Hjerter D	N 8	300	-8,0	8,0
14	31	5	3 NT	Ø 9	600	-12,0	12,0
5	22	14	3 NT	Ø 9	600	-12,0	12,0
15	4	32	3 NT	Ø 10	630	-15,0	15,0
20	38	37	4 Spar D	V 10	790	-18,0	18,0
4	15	21	4 Spar D	V 10	790	-18,0	18,0

Mappnr: 23(55)

Rundenr: 19

Syd / Alle

♠ Q932
♥ 98
♦ A974
♣ J62

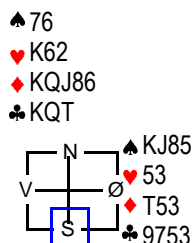

♠ AT4
♥ AQJT74
♦ 2
♣ A84

Bord	NS	ØV		NS	ØV	NS	ØV
19	37	1	6 Hjerter	S 12	1430	13,0	-13,0
3	17	21	6 Hjerter	S 12	1430	13,0	-13,0
16	4	34	6 Hjerter	S 12	1430	13,0	-13,0
14	32	6	6 Hjerter	S 12	1430	13,0	-13,0
6	14	24	6 Hjerter	S 12	1430	13,0	-13,0
12	8	30	6 Hjerter	S 12	1430	13,0	-13,0
7	13	25	6 Hjerter	S 12	1430	13,0	-13,0
5	23	15	4 Hjerter	S 12	680	4,0	-4,0
20	39	38	4 Hjerter	S 12	680	4,0	-4,0
11	29	9	4 Hjerter	S 11	650	-2,0	2,0
2	18	20	4 Hjerter	S 11	650	-2,0	2,0
10	10	28	4 Hjerter	N 11	650	-2,0	2,0
17	35	3	4 Hjerter	S 11	650	-2,0	2,0
1	40	19	6 Hjerter	S 11	100	-13,0	13,0
8	12	26	6 Hjerter	S 11	100	-13,0	13,0
13	7	31	6 Hjerter	S 11	100	-13,0	13,0
15	5	33	6 Hjerter	S 11	100	-13,0	13,0
4	16	22	6 Hjerter	S 11	100	-13,0	13,0
18	36	2	6 Hjerter	S 11	100	-13,0	13,0
9	27	11	6 Hjerter	S 11	100	-13,0	13,0

Mappnr: 24(56)

Rundenr: 19

Vest / Ingen

♠ JT42
♥ K83
♦ 52
♣ AK76

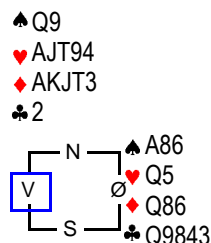

♠ K753
♥ 762
♦ 974
♣ JT5

Bord	NS	ØV		NS	ØV	NS	ØV
10	10	28	3 Hjerter	N 9	140	19,0	-19,0
2	18	20	2 Hjerter	N 8	110	17,0	-17,0
12	8	30	3 Spar	V 8	50	14,0	-14,0
3	17	21	4 Kløver	Ø 9	50	14,0	-14,0
19	37	1	3 Hjerter	N 8	50	3,0	-3,0
16	4	34	3 Hjerter	N 8	50	3,0	-3,0
15	5	33	3 Hjerter	N 8	50	3,0	-3,0
20	39	38	3 Hjerter	N 8	50	3,0	-3,0
5	23	15	3 Hjerter	N 8	50	3,0	-3,0
1	40	19	3 Hjerter	N 8	50	3,0	-3,0
6	14	24	3 Hjerter	N 8	50	3,0	-3,0
4	16	22	3 Ruter	S 8	50	3,0	-3,0
14	32	6	4 Hjerter	N 9	50	3,0	-3,0
7	13	25	3 Hjerter D	N 8	100	-8,0	8,0
11	29	9	3 Hjerter	N 7	100	-8,0	8,0
8	12	26	2 Spar	Ø 8	110	-13,0	13,0
17	35	3	2 Spar	V 8	110	-13,0	13,0
9	27	11	2 Spar	V 8	110	-13,0	13,0
13	7	31	3 Hjerter	S 6	150	-17,0	17,0
18	36	2	3 Hjerter D	N 7	300	-19,0	19,0

SPILLSTENSILER

Kragerøcupen 2008, 23.-24. august 2008

Mappen: 25(57)

Runden: 19

Nord / ØV

♠ AJT876

♥ QJ

♦ K874

♣ K

♠ KQ3

♥ A73

♦ AJT

♣ AJ53

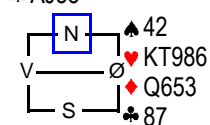

♠ 95

♥ 542

♦ 92

♣ QT9642

Bord	NS	ØV	NS	ØV	NS	ØV
11	29	9	Pass		0,0	0,0
2	18	20	Pass		0,0	0,0
3	17	21	Pass		0,0	0,0
4	16	22	Pass		0,0	0,0
5	23	15	Pass		0,0	0,0
6	14	24	Pass		0,0	0,0
7	13	25	Pass		0,0	0,0
8	12	26	Pass		0,0	0,0
1	40	19	Pass		0,0	0,0
10	10	28	Pass		0,0	0,0
20	39	38	Pass		0,0	0,0
12	8	30	Pass		0,0	0,0
13	7	31	Pass		0,0	0,0
14	32	6	Pass		0,0	0,0
15	5	33	Pass		0,0	0,0
16	4	34	Pass		0,0	0,0
17	35	3	Pass		0,0	0,0
18	36	2	Pass		0,0	0,0
19	37	1	Pass		0,0	0,0
9	27	11	Pass		0,0	0,0

Mappen: 26(58)

Runden: 20

Øst / Alle

♠ QJ9

♥

♦ J8543

♣ Q5432

♠ A8

♥ AQT86

♦ A92

♣ A97

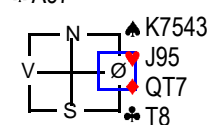

♠ T62

♥ K7432

♦ K6

♣ KJ6

Bord	NS	ØV	NS	ØV	NS	ØV
9	28	12	6 Hjerter	S 12	1430	19,0 -19,0
3	18	22	4 Hjerter	N 12	680	10,0 -10,0
4	17	23	4 Hjerter	N 12	680	10,0 -10,0
7	14	26	4 Hjerter	N 12	680	10,0 -10,0
1	40	20	4 Hjerter	N 12	680	10,0 -10,0
11	30	10	4 Hjerter	N 12	680	10,0 -10,0
13	8	32	4 Hjerter	N 12	680	10,0 -10,0
14	33	7	4 Hjerter	N 12	680	10,0 -10,0
10	11	29	4 Hjerter	S 12	680	10,0 -10,0
12	9	31	4 Hjerter	N 11	650	-8,0 8,0
20	1	39	4 Hjerter	N 11	650	-8,0 8,0
15	6	34	4 Hjerter	S 11	650	-8,0 8,0
16	5	35	4 Hjerter	N 11	650	-8,0 8,0
8	13	27	4 Hjerter	N 11	650	-8,0 8,0
17	36	4	4 Hjerter	S 11	650	-8,0 8,0
6	15	25	4 Hjerter	N 11	650	-8,0 8,0
5	24	16	4 Hjerter	N 11	650	-8,0 8,0
19	38	2	4 Hjerter	N 11	650	-8,0 8,0
2	19	21	4 Hjerter	N 11	650	-8,0 8,0
18	37	3	6 Ruter	N 11	100	-19,0 19,0

Mappen: 27(59)

Runden: 20

Syd / Ingen

♠ 72

♥ AKQ875

♦ Q873

♣ 4

♠ AK84

♥ J42

♦ A64

♣ K82

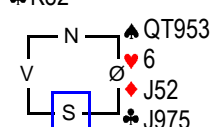

♠ J6

♥ T93

♦ KT9

♣ AQT63

Bord	NS	ØV	NS	ØV	NS	ØV
9	28	12	3 NT	N 10	430	19,0 -19,0
4	17	23	3 Hjerter	D V 7	300	17,0 -17,0
1	40	20	3 Hjerter	V 6	150	15,0 -15,0
5	24	16	3 Kløver	S 9	110	6,0 -6,0
6	15	25	3 Kløver	S 9	110	6,0 -6,0
8	13	27	3 Kløver	S 9	110	6,0 -6,0
11	30	10	3 Kløver	S 9	110	6,0 -6,0
12	9	31	3 Kløver	S 9	110	6,0 -6,0
14	33	7	3 Kløver	S 9	110	6,0 -6,0
17	36	4	3 Kløver	S 9	110	6,0 -6,0
10	11	29	3 Kløver	S 9	110	6,0 -6,0
3	18	22	3 Hjerter	V 7	100	-3,0 3,0
15	6	34	4 Kløver	S 9	50	-9,0 9,0
16	5	35	4 Kløver	S 9	50	-9,0 9,0
7	14	26	4 Kløver	S 9	50	-9,0 9,0
18	37	3	4 Kløver	S 9	50	-9,0 9,0
2	19	21	4 Kløver	S 9	50	-9,0 9,0
20	1	39	3 NT	N 7	100	-17,0 17,0
19	38	2	3 NT	S 7	100	-17,0 17,0
13	8	32	5 Kløver	S 9	100	-17,0 17,0

Mappen: 28(60)

Runden: 20

Vest / N/S

♠ 73

♥ 873

♦ AQ875

♣ AK6

♠ JT942

♥ Q65

♦ 94

♣ 953

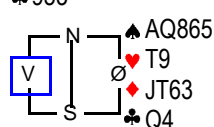

♠ K

♥ AKJ42

♦ K2

♣ JT872

Bord	NS	ØV	NS	ØV	NS	ØV
10	11	29	3 Spar D	V 7	300	19,0 -19,0
20	1	39	1 Spar D	Ø 6	100	17,0 -17,0
11	30	10	3 Spar	Ø 8	50	15,0 -15,0
8	13	27	3 Ruter	V 10	130	6,0 -6,0
16	5	35	3 Ruter	V 10	130	6,0 -6,0
14	33	7	3 Ruter	V 10	130	6,0 -6,0
2	19	21	3 Ruter	V 10	130	6,0 -6,0
17	36	4	3 Ruter	V 10	130	6,0 -6,0
5	24	16	3 Ruter	V 10	130	6,0 -6,0
9	28	12	3 Ruter	V 10	130	6,0 -6,0
15	6	34	4 Ruter	V 10	130	6,0 -6,0
3	18	22	3 Ruter	V 11	150	-10,0 10,0
4	17	23	3 Ruter	V 11	150	-10,0 10,0
7	14	26	3 Ruter	V 11	150	-10,0 10,0
1	40	20	3 Ruter	V 11	150	-10,0 10,0
18	37	3	3 Ruter	V 11	150	-10,0 10,0
13	8	32	3 Ruter	V 11	150	-10,0 10,0
6	15	25	4 Ruter	V 11	150	-10,0 10,0
19	38	2	4 Ruter	V 11	150	-10,0 10,0
12	9	31	3 Ruter	V 12	170	-19,0 19,0

SPILLSTENSILER

Kragerøcupen 2008, 23.-24. august 2008

Mappen: 29(61)

Runden: 21

Nord / Alle

♠ K75
♥ K97
♦ J753
♣ 974

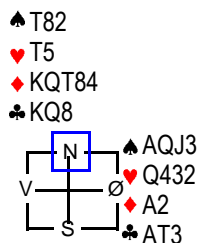

♠ 964
♥ AJ86
♦ 96
♣ J652

Bord	NS	ØV		NS	ØV	NS	ØV
3	19	23	2 Ruter	N 9	110	19,0	-19,0
11	31	11	2 NT	Ø 7	100	17,0	-17,0
8	14	28	1 NT	Ø 7	90	12,0	-12,0
10	12	30	1 NT	Ø 7	90	12,0	-12,0
20	2	1	1 NT	Ø 7	90	12,0	-12,0
9	29	13	1 NT	Ø 7	90	12,0	-12,0
15	7	35	1 NT	Ø 8	120	-3,0	3,0
14	34	8	1 NT	Ø 8	120	-3,0	3,0
13	9	33	1 NT	Ø 8	120	-3,0	3,0
12	10	32	1 NT	Ø 8	120	-3,0	3,0
17	37	5	1 NT	Ø 8	120	-3,0	3,0
1	40	21	1 NT	Ø 8	120	-3,0	3,0
18	38	4	1 NT	Ø 8	120	-3,0	3,0
7	15	27	1 NT	Ø 8	120	-3,0	3,0
6	16	26	1 NT	V 8	120	-3,0	3,0
5	25	17	1 NT	Ø 8	120	-3,0	3,0
19	39	3	1 NT	Ø 8	120	-3,0	3,0
16	6	36	1 NT	Ø 9	150	-15,0	15,0
2	20	22	2 Ruter D	S 7	200	-17,0	17,0
4	18	24	2 Ruter D	N 6	500	-19,0	19,0

Mappen: 30(62)

Runden: 21

Øst / Ingen

♠ AT52
♥ 62
♦ JT9762
♣ Q

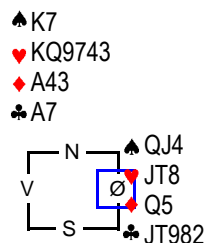

♠ 9863
♥ A5
♦ K8
♣ K6543

Bord	NS	ØV		NS	ØV	NS	ØV
1	40	21	6 Hjerter	N 12	980	19,0	-19,0
10	12	30	4 Hjerter	N 12	480	11,0	-11,0
4	18	24	4 Hjerter	N 12	480	11,0	-11,0
5	25	17	4 Hjerter	N 12	480	11,0	-11,0
9	29	13	4 Hjerter	N 12	480	11,0	-11,0
12	10	32	4 Hjerter	N 12	480	11,0	-11,0
18	38	4	4 Hjerter	N 12	480	11,0	-11,0
19	39	3	4 Hjerter	N 12	480	11,0	-11,0
13	9	33	3 NT	S 11	460	2,0	-2,0
7	15	27	3 NT	S 11	460	2,0	-2,0
2	20	22	4 Hjerter	N 11	450	-1,0	1,0
3	19	23	3 NT	S 10	430	-3,0	3,0
14	34	8	4 Hjerter	N 10	420	-8,0	8,0
20	2	1	4 Hjerter	N 10	420	-8,0	8,0
17	37	5	4 Hjerter	N 10	420	-8,0	8,0
11	31	11	4 Hjerter	N 10	420	-8,0	8,0
15	7	35	3 NT	S 9	400	-13,0	13,0
16	6	36	2 Hjerter	N 11	200	-16,0	16,0
6	16	26	2 Hjerter	N 11	200	-16,0	16,0
8	14	28	4 Hjerter	N 8	100	-19,0	19,0

Mappen: 31(63)

Runden: 21

Syd / N/S

♠ JT93
♥ AQ4
♦ 76
♣ 7432

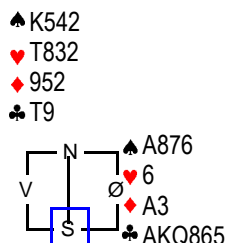

♠ Q
♥ KJ975
♦ KQJT84
♣ J

Bord	NS	ØV		NS	ØV	NS	ØV
18	38	4	4 Spar	V 9	50	18,0	-18,0
15	7	35	4 Spar	V 9	50	18,0	-18,0
19	39	3	5 Kløver	Ø 11	400	15,0	-15,0
9	29	13	4 Spar	V 10	420	8,0	-8,0
16	6	36	4 Spar	V 10	420	8,0	-8,0
14	34	8	4 Spar	V 10	420	8,0	-8,0
12	10	32	4 Spar	V 10	420	8,0	-8,0
6	16	26	4 Spar	V 10	420	8,0	-8,0
8	14	28	4 Spar	V 10	420	8,0	-8,0
20	2	1	3 NT	V 10	430	1,0	-1,0
2	20	22	4 Spar	V 11	450	-7,0	7,0
3	19	23	4 Spar	V 11	450	-7,0	7,0
4	18	24	4 Spar	V 11	450	-7,0	7,0
7	15	27	4 Spar	V 11	450	-7,0	7,0
11	31	11	4 Spar	V 11	450	-7,0	7,0
17	37	5	4 Spar	V 11	450	-7,0	7,0
10	12	30	4 Spar	V 11	450	-7,0	7,0
13	9	33	4 Spar	V 12	480	-15,0	15,0
1	40	21	4 Spar D	V 10	590	-17,0	17,0
5	25	17	5 Hjerter D	S 8	800	-19,0	19,0

Mappen: 32(64)

Runden: 22

Vest / Ø/V

♠ Q
♥ KQ53
♦ A83
♣ KT873

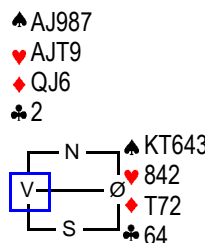

♠ 52
♥ 76
♦ K954
♣ AQJ95

Bord	NS	ØV		NS	ØV	NS	ØV
6	17	27	2 Kløver D	V 4	1100	19,0	-19,0
18	39	5	3 NT	S 9	400	16,0	-16,0
15	8	36	3 NT	S 9	400	16,0	-16,0
17	38	6	2 NT	S 9	150	13,0	-13,0
19	1	4	2 Spar	N 9	140	7,0	-7,0
13	10	34	2 Spar	N 9	140	7,0	-7,0
2	21	23	2 Spar	N 9	140	7,0	-7,0
3	20	24	2 Spar	N 9	140	7,0	-7,0
4	19	25	2 Spar	N 9	140	7,0	-7,0
9	30	14	2 NT	S 8	120	-1,0	1,0
16	7	37	2 NT	S 8	120	-1,0	1,0
14	35	9	2 NT	S 8	120	-1,0	1,0
8	15	29	2 Spar	N 8	110	-7,0	7,0
1	40	22	2 Spar	N 8	110	-7,0	7,0
10	13	31	2 Spar	N 8	110	-7,0	7,0
20	3	2	1 NT	S 7	90	-11,0	11,0
12	11	33	3 NT	S 8	50	-13,0	13,0
7	16	28	3 NT	S 7	100	-17,0	17,0
5	26	18	3 NT	S 7	100	-17,0	17,0
11	32	12	4 Spar	N 8	100	-17,0	17,0

SPILLSTENSILER

Kragerøcupen 2008, 23.-24. august 2008

Mappen: **1(65)**

Runden: **22**

Nord / Ingen

- ♠ AT5
- ♥ AK875
- ♦ 432
- ♣ K5

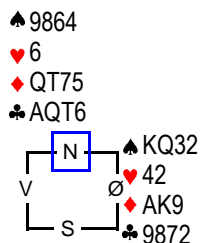

- ♠ J7
- ♥ QJT93
- ♦ J86
- ♣ J43

Bord	NS	ØV	NS	ØV	NS	ØV
12	11	33 3NT	V 6	150	19,0	-19,0
3	20	24 3NT	V 7	100	15,0	-15,0
4	19	25 3NT	Ø 7	100	15,0	-15,0
1	40	22 3NT	Ø 7	100	15,0	-15,0
5	26	18 3 Hjerter	Ø 8	50	0,0	0,0
11	32	12 3NT	V 8	50	0,0	0,0
7	16	28 3NT	Ø 8	50	0,0	0,0
8	15	29 3NT	Ø 8	50	0,0	0,0
10	13	31 3NT	Ø 8	50	0,0	0,0
20	3	2 3NT	Ø 8	50	0,0	0,0
13	10	34 3NT	Ø 8	50	0,0	0,0
14	35	9 3NT	V 8	50	0,0	0,0
15	8	36 3NT	V 8	50	0,0	0,0
16	7	37 3NT	V 8	50	0,0	0,0
19	1	4 3NT	Ø 8	50	0,0	0,0
9	30	14 3NT	Ø 8	50	0,0	0,0
17	38	6 2 Hjerter D	N 6	300	-13,0	13,0
6	17	27 3NT	V 9	400	-17,0	17,0
18	39	5 3NT	Ø 9	400	-17,0	17,0
2	21	23 3NT	Ø 9	400	-17,0	17,0

Mappen: **2(66)**

Runden: **22**

Øst / N/S

- ♠ AJ9
- ♥ KQ643
- ♦ Q
- ♣ 8632

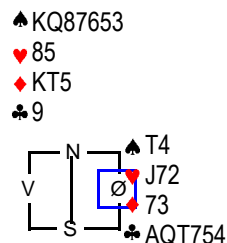

- ♠ 2
- ♥ AT9
- ♦ AJ98642
- ♣ KJ

Bord	NS	ØV	NS	ØV	NS	ØV
8	15	29 5 Ruter D	S 11	750	19,0	-19,0
11	32	12 4 Spar	N 10	620	13,0	-13,0
6	17	27 4 Spar	N 10	620	13,0	-13,0
1	40	22 4 Spar	N 10	620	13,0	-13,0
9	30	14 4 Spar	N 10	620	13,0	-13,0
20	3	2 4 Spar	N 10	620	13,0	-13,0
19	1	4 5 Ruter	S 11	600	7,0	-7,0
17	38	6 4 Hjerter D	V 9	100	3,0	-3,0
7	16	28 5 Kløver D	V 10	100	3,0	-3,0
2	21	23 5 Kløver D	Ø 10	100	3,0	-3,0
10	13	31 5 Kløver	Ø 10	50	-1,0	1,0
14	35	9 4 Spar	N 9	100	-8,0	8,0
12	11	33 4 Spar	N 9	100	-8,0	8,0
4	19	25 4 Spar	N 9	100	-8,0	8,0
3	20	24 4 Spar	N 9	100	-8,0	8,0
15	8	36 5 Ruter	S 10	100	-8,0	8,0
13	10	34 5 Spar	N 10	100	-8,0	8,0
16	7	37 6 Ruter	S 10	200	-17,0	17,0
18	39	5 6 Ruter	S 10	200	-17,0	17,0
5	26	18 6 Ruter	S 10	200	-17,0	17,0

Mappen: **3(67)**

Runden: **23**

Syd / ØV

- ♠ Q2
- ♥ Q8
- ♦ JT632
- ♣ JT64

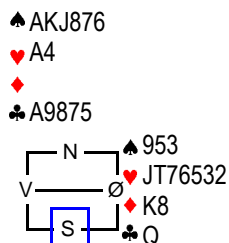

- ♠ T4
- ♥ K9
- ♦ AQ9754
- ♣ K32

Bord	NS	ØV	NS	ØV	NS	ØV
18	1	6 6 Spar	N 12	980	17,8	-17,8
7	17	29 6 Spar	N 12	980	17,8	-17,8
19	2	5 6 Kløver	N 12	920	14,4	-14,4
9	31	15 3NT	S 12	490	11,1	-11,1
4	20	26 3NT	S 12	490	11,1	-11,1
2	22	24 4 Spar	N 12	480	4,4	-4,4
15	9	37 4 Spar	N 12	480	4,4	-4,4
6	18	28 4 Spar	N 12	480	4,4	-4,4
12	12	34 4 Spar	N 12	480	4,4	-4,4
13	11	35 60%-40%			3,8	-3,8
20	4	3 60%-40%			3,8	-3,8
1	40	23 3NT	S 11	460	-1,1	1,1
11	33	13 4 Spar	N 11	450	-4,4	4,4
10	14	32 4 Spar	N 11	450	-4,4	4,4
17	7	39 3 Kløver	N 12	170	-7,8	7,8
14	36	10 4 Kløver	N 11	150	-10,0	10,0
8	16	30 6 Kløver	N 11	50	-15,6	15,6
16	8	38 6 Kløver	N 11	50	-15,6	15,6
5	27	19 6 Spar	N 11	50	-15,6	15,6
3	21	25 7 Spar	N 12	50	-15,6	15,6

Mappen: **4(68)**

Runden: **23**

Vest / Alle

- ♠ A765
- ♥ A
- ♦ AJ875
- ♣ 983

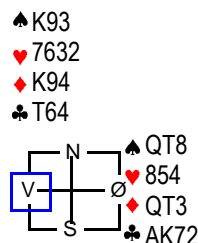

- ♠ J42
- ♥ KQJT9
- ♦ 62
- ♣ QJ5

Bord	NS	ØV	NS	ØV	NS	ØV
11	33	13 3NT	Ø 8	100	15,8	-15,8
5	27	19 3NT	Ø 8	100	15,8	-15,8
17	7	39 3NT	Ø 8	100	15,8	-15,8
10	14	32 3 Ruter	V 8	100	15,8	-15,8
7	17	29 3 Ruter	V 9	110	7,4	-7,4
2	22	24 3 Ruter	V 9	110	7,4	-7,4
4	20	26 3 Ruter	V 9	110	7,4	-7,4
18	1	6 3 Ruter	V 9	110	7,4	-7,4
13	11	35 60%-40%			3,8	-3,8
9	31	15 1NT	Ø 8	120	-3,2	3,2
8	16	30 1NT	Ø 8	120	-3,2	3,2
16	8	38 1NT	Ø 8	120	-3,2	3,2
12	12	34 1NT	Ø 8	120	-3,2	3,2
6	18	28 2NT	Ø 8	120	-3,2	3,2
14	36	10 2NT	Ø 8	120	-3,2	3,2
19	2	5 2 Spar	Ø 10	170	-10,5	10,5
3	21	25 2 Hjerter D	S 7	200	-14,7	14,7
15	9	37 2 Hjerter D	S 7	200	-14,7	14,7
20	4	3 3 Hjerter	S 7	200	-14,7	14,7
1	40	23 3 Hjerter D	S 7	500	-18,9	18,9

SPILLSTENSILER

Kragerøcupen 2008, 23.-24. august 2008

Mappnr: 5(69)

Rundenr: 23

Nord / N/S

♠ Q543

♥ 3

♦ 2

♣ AKJT984

♠ JT97

♥ AT4

♦ 98643

♣ 6

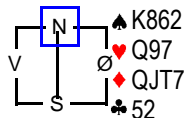

♠ A

♥ KJ8652

♦ AK5

♣ Q73

Bord	NS	ØV	NS	ØV	NS	ØV
18	1	6 4 Spar D	Ø 5	1100	19,0	-19,0
5	27	19 5 Kløver D	V 7	800	16,0	-16,0
1	40	23 5 Kløver D	V 7	800	16,0	-16,0
9	31	15 4 Hjerter	S 10	620	11,0	-11,0
15	9	37 4 Hjerter	S 10	620	11,0	-11,0
7	17	29 4 Hjerter	S 10	620	11,0	-11,0
2	22	24 4 Spar D	Ø 7	500	5,0	-5,0
4	20	26 4 Spar D	V 7	500	5,0	-5,0
14	36	10 5 Kløver D	V 8	500	5,0	-5,0
19	2	5 4 Spar D	V 8	300	-2,0	2,0
3	21	25 4 Spar D	V 8	300	-2,0	2,0
6	18	28 4 Spar D	V 8	300	-2,0	2,0
8	16	30 5 Kløver D	V 9	300	-2,0	2,0
10	14	32 3 NT	Ø 4	250	-7,0	7,0
12	12	34 3 Hjerter	S 10	170	-9,0	9,0
17	7	39 3 Spar	V 6	150	-11,0	11,0
11	33	13 3 Hjerter	S 9	140	-13,0	13,0
16	8	38 4 Kløver	V 8	100	-16,0	16,0
20	4	3 4 Spar D	Ø 9	100	-16,0	16,0
13	11	35 5 Hjerter	S 10	100	-19,0	19,0

Mappnr: 6(70)

Rundenr: 24

Øst / Ø/V

♠ 542

♥ KJ8

♦ 9732

♣ KT8

♠ Q

♥ A9542

♦ AKQJ6

♣ 63

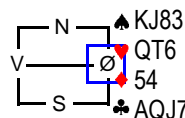

♠ AT976

♥ 73

♦ T8

♣ 9542

Bord	NS	ØV	NS	ØV	NS	ØV
19	3	6 2 NT D	V 6	500	19,0	-19,0
1	40	24 1 NT	V 5	200	16,0	-16,0
13	12	36 2 Spar	V 6	200	16,0	-16,0
5	28	20 3 Hjerter	N 10	170	13,0	-13,0
11	34	14 2 Hjerter	N 9	140	-1,0	1,0
2	23	25 2 Hjerter	N 9	140	-1,0	1,0
3	22	26 2 Hjerter	N 9	140	-1,0	1,0
4	21	27 2 Hjerter	N 9	140	-1,0	1,0
6	19	29 2 Hjerter	N 9	140	-1,0	1,0
8	17	31 2 Hjerter	N 9	140	-1,0	1,0
10	15	33 2 Hjerter	N 9	140	-1,0	1,0
20	5	4 2 Hjerter	N 9	140	-1,0	1,0
12	13	35 2 Hjerter	N 9	140	-1,0	1,0
14	37	11 2 Hjerter	N 9	140	-1,0	1,0
15	10	38 2 Hjerter	N 9	140	-1,0	1,0
16	9	39 2 Hjerter	N 9	140	-1,0	1,0
9	32	16 2 Hjerter	N 9	140	-1,0	1,0
7	18	30 2 Hjerter	N 8	110	-17,0	17,0
17	1	8 2 Hjerter	N 8	110	-17,0	17,0
18	2	7 2 Hjerter	N 8	110	-17,0	17,0

Mappnr: 7(71)

Rundenr: 24

Syd / Alle

♠ J863

♥ A983

♦ AKJ

♣ 63

♠ KQ75

♥ 76

♦ 42

♣ A8542

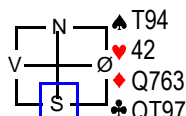

♠ A2

♥ KQJT5

♦ T985

♣ KJ

Bord	NS	ØV	NS	ØV	NS	ØV
9	32	16 2 Spar D	Ø 5	800	19,0	-19,0
2	23	25 3 NT	S 9	600	16,0	-16,0
20	5	4 3 NT	S 9	600	16,0	-16,0
19	3	6 2 Spar D	Ø 6	500	13,0	-13,0
15	10	38 2 Kløver	Ø 4	400	11,0	-11,0
3	22	26 1 NT	S 9	150	5,0	-5,0
4	21	27 1 NT	N 9	150	5,0	-5,0
13	12	36 1 NT	S 9	150	5,0	-5,0
1	40	24 1 NT	N 9	150	5,0	-5,0
14	37	11 2 NT	N 9	150	5,0	-5,0
5	28	20 2 Hjerter	S 9	140	-8,0	8,0
6	19	29 2 Hjerter	S 9	140	-8,0	8,0
7	18	30 2 Hjerter	S 9	140	-8,0	8,0
8	17	31 2 Hjerter	S 9	140	-8,0	8,0
10	15	33 2 Hjerter	S 9	140	-8,0	8,0
16	9	39 2 Hjerter	S 9	140	-8,0	8,0
17	1	8 2 Hjerter	S 9	140	-8,0	8,0
18	2	7 2 Hjerter	S 9	140	-8,0	8,0
11	34	14 2 Hjerter	S 8	110	-18,0	18,0
12	13	35 2 Kløver	N 9	110	-18,0	18,0

Mappnr: 8(72)

Rundenr: 24

Vest / Ingen

♠ KQ4

♥ T8742

♦ 95

♣ Q32

♠ J976

♥ K653

♦ K2

♣ KT9

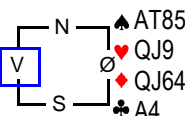

♠ 32

♥ A

♦ AT873

♣ J8765

Bord	NS	ØV	NS	ØV	NS	ØV
5	28	20 2 Spar	Ø 5	150	19,0	-19,0
2	23	25 3 Kløver	S 10	130	13,0	-13,0
3	22	26 3 Kløver	N 10	130	13,0	-13,0
6	19	29 3 Kløver	N 10	130	13,0	-13,0
8	17	31 3 Kløver	N 10	130	13,0	-13,0
20	5	4 4 Kløver	N 10	130	13,0	-13,0
1	40	24 3 Kløver	S 9	110	7,0	-7,0
12	13	35 3 Hjerter D	V 8	100	5,0	-5,0
4	21	27 2 Hjerter	V 7	50	-1,0	1,0
18	2	7 2 Spar	Ø 7	50	-1,0	1,0
14	37	11 3 Hjerter	V 8	50	-1,0	1,0
13	12	36 3 Hjerter	V 8	50	-1,0	1,0
11	34	14 3 Spar	Ø 8	50	-1,0	1,0
7	18	30 1 Spar	Ø 7	80	-8,0	8,0
10	15	33 1 Spar	Ø 7	80	-8,0	8,0
16	9	39 2 Hjerter	V 8	110	-12,0	12,0
19	3	6 2 Hjerter	V 8	110	-12,0	12,0
17	1	8 2 NT	S 4	200	-17,0	17,0
15	10	38 3 NT	S 5	200	-17,0	17,0
9	32	16 3 NT	N 5	200	-17,0	17,0

SPILLSTENSILER

Kragerøcupen 2008, 23.-24. august 2008

Mappen: 9(73)

Runden: 25

Nord / ØV

♠ 975
♥ K6432
♦ 8742
♣ 5

♠ AQT62

♥ AQT

♦ 653

♣ KJ

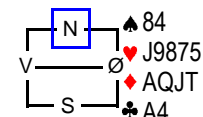

♠ KJ3

♥ K9

♦ QT987632

♣ QT987632

Bord	NS	ØV	NS	ØV	NS	ØV
2	24	26	4 Spar	S 12	480	16,0 -16,0
15	11	39	4 Spar	N 12	480	16,0 -16,0
5	29	21	4 Spar	N 12	480	16,0 -16,0
1	40	25	4 Spar	N 12	480	16,0 -16,0
9	33	17	4 Spar	N 11	450	9,0 -9,0
14	38	12	4 Spar	N 11	450	9,0 -9,0
12	14	36	4 Spar	N 11	450	9,0 -9,0
17	2	9	4 Spar	N 10	420	4,0 -4,0
20	6	5	4 Spar	N 10	420	4,0 -4,0
4	22	28	3 NT	N 9	400	-1,0 1,0
13	13	37	3 NT	N 9	400	-1,0 1,0
3	23	27	5 Kløver	S 11	400	-1,0 1,0
10	16	34	4 Kløver	S 12	170	-5,0 5,0
6	20	30	6 Kløver	S 11	50	-8,0 8,0
18	3	8	6 Kløver	S 11	50	-8,0 8,0
8	18	32	6 Kløver D	N 11	100	-13,0 13,0
7	19	31	6 Kløver D	S 11	100	-13,0 13,0
11	35	15	6 Spar	N 10	100	-13,0 13,0
19	4	7	6 Spar D	N 10	300	-17,0 17,0
16	10	1	6 NT D	N 9	500	-19,0 19,0

Mappen: 10(74)

Runden: 25

Øst / Alle

♠ KQ
♥ Q98532
♦ K54
♣ 32

♠ J865

♥ 76

♦ A976

♣ KQ6

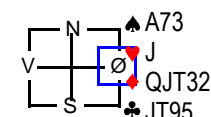

♠ T942

♥ AKT4

♦ 8

♣ A874

Bord	NS	ØV	NS	ØV	NS	ØV
16	10	1	2 Spar D	S 9	870	19,0 -19,0
5	29	21	4 Spar	N 10	620	17,0 -17,0
2	24	26	2 Hjerter	V 6	200	13,0 -13,0
20	6	5	2 Hjerter	Ø 6	200	13,0 -13,0
1	40	25	2 Hjerter	V 6	200	13,0 -13,0
11	35	15	2 Spar	S 10	170	5,0 -5,0
3	23	27	2 Spar	S 10	170	5,0 -5,0
15	11	39	2 Spar	S 10	170	5,0 -5,0
6	20	30	2 Spar	N 10	170	5,0 -5,0
12	14	36	2 Spar	S 10	170	5,0 -5,0
7	19	31	2 Spar	N 9	140	-8,0 8,0
10	16	34	2 Spar	S 9	140	-8,0 8,0
13	13	37	2 Spar	S 9	140	-8,0 8,0
14	38	12	2 Spar	N 9	140	-8,0 8,0
17	2	9	2 Spar	S 9	140	-8,0 8,0
18	3	8	2 Spar	S 9	140	-8,0 8,0
19	4	7	2 Spar	S 9	140	-8,0 8,0
9	33	17	3 Spar	S 9	140	-8,0 8,0
8	18	32	2 Hjerter	V 7	100	-17,0 17,0
4	22	28	4 Spar D	S 8	500	-19,0 19,0

Mappen: 11(75)

Runden: 25

Syd / Ingen

♠ T3
♥ K932
♦ 75
♣ AJ532

♠ AKQ42

♥ Q6

♦ AT83

♣ T7

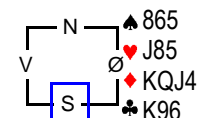

♠ J97

♥ AT74

♦ 962

♣ Q84

Bord	NS	ØV	NS	ØV	NS	ØV
19	4	7	4 Kløver D	V 8	300	19,0 -19,0
11	35	15	1 NT	N 10	180	17,0 -17,0
14	38	12	2 Spar	N 10	170	15,0 -15,0
6	20	30	3 Spar	N 9	140	12,0 -12,0
20	6	5	3 Spar	N 9	140	12,0 -12,0
16	10	1	1 NT	N 8	120	9,0 -9,0
2	24	26	2 Spar	N 8	110	-3,0 3,0
3	23	27	2 Spar	N 8	110	-3,0 3,0
5	29	21	2 Spar	N 8	110	-3,0 3,0
8	18	32	2 Spar	N 8	110	-3,0 3,0
10	16	34	2 Spar	N 8	110	-3,0 3,0
12	14	36	2 Spar	N 8	110	-3,0 3,0
13	13	37	2 Spar	N 8	110	-3,0 3,0
15	11	39	2 Spar	N 8	110	-3,0 3,0
17	2	9	2 Spar	N 8	110	-3,0 3,0
18	3	8	2 Spar	N 8	110	-3,0 3,0
9	33	17	2 Spar	N 8	110	-3,0 3,0
7	19	31	1 NT	N 7	90	-15,0 15,0
4	22	28	1 NT	N 6	50	-18,0 18,0
1	40	25	3 Spar	N 8	50	-18,0 18,0

Mappen: 12(76)

Runden: 26

Vest / N/S

♠ J73
♥ 7643
♦ AQJ873

♠ Q753

♥ Q42

♦ JT52

♣ 52

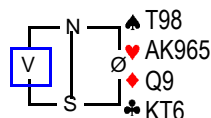

♠ AKJ642

♥ T8

♦ AK8

♣ 94

Bord	NS	ØV	NS	ØV	NS	ØV
12	15	37	5 Spar D	S 11	850	19,0 -19,0
18	4	9	4 Spar	S 10	620	15,0 -15,0
3	24	28	4 Spar	S 10	620	15,0 -15,0
4	23	29	4 Spar	S 10	620	15,0 -15,0
5	30	22	6 Kløver D	V 10	300	11,0 -11,0
15	12	1	3 NT	Ø 4	250	9,0 -9,0
6	21	31	3 Spar	N 10	170	6,0 -6,0
13	14	38	3 Spar	S 10	170	6,0 -6,0
2	25	27	4 Hjerter D	Ø 9	100	0,0 0,0
1	40	26	5 Kløver D	V 10	100	0,0 0,0
17	3	10	5 Kløver D	V 10	100	0,0 0,0
19	5	8	5 Kløver D	V 10	100	0,0 0,0
10	17	35	4 Spar	S 9	100	-5,0 5,0
8	19	33	4 Kløver	V 10	130	-8,0 8,0
7	20	32	4 Kløver	V 10	130	-8,0 8,0
16	11	2	3 Kløver	V 11	150	-11,0 11,0
14	39	13	4 Spar D	N 9	200	-13,0 13,0
11	36	16	3 Hjerter	Ø 12	230	-15,0 15,0
9	34	18	4 Hjerter	Ø 10	420	-17,0 17,0
20	7	6	5 Hjerter	Ø 11	450	-19,0 19,0

SPILLSTENSILER

Kragerøcupen 2008, 23.-24. august 2008

Mappen: 13(77)
Runden: 26

Nord / Alle

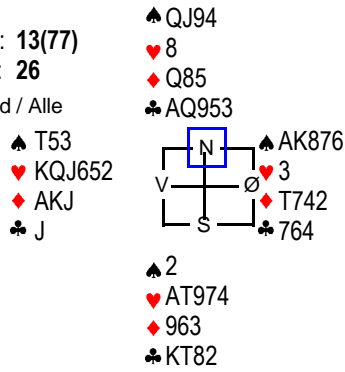

Bord	NS	ØV		NS	ØV	NS	ØV
20	7	6	3 Hjerter D	V 8	200	17,0	-17,0
6	21	31	4 Spar D	Ø 9	200	17,0	-17,0
16	11	2	4 Spar D	Ø 9	200	17,0	-17,0
8	19	33	3 Kløver	N 9	110	13,0	-13,0
2	25	27	3 Hjerter	V 8	100	7,0	-7,0
14	39	13	3 Hjerter	V 8	100	7,0	-7,0
4	23	29	4 Spar	Ø 9	100	7,0	-7,0
13	14	38	4 Spar	Ø 9	100	7,0	-7,0
19	5	8	4 Spar	Ø 9	100	7,0	-7,0
18	4	9	2 Kløver	N 8	90	1,0	-1,0
3	24	28	2 Hjerter	V 9	140	-3,0	3,0
12	15	37	2 Hjerter	V 9	140	-3,0	3,0
15	12	1	3 Spar	V 9	140	-3,0	3,0
11	36	16	3 Spar	Ø 10	170	-7,0	7,0
1	40	26	5 Kløver	N 9	200	-9,0	9,0
17	3	10	4 Spar	Ø 10	620	-12,0	12,0
7	20	32	4 Spar	Ø 10	620	-12,0	12,0
5	30	22	4 Spar D	Ø 10	790	-17,0	17,0
10	17	35	4 Spar D	V 10	790	-17,0	17,0
9	34	18	4 Spar D	Ø 10	790	-17,0	17,0

Mappen: 14(78)
Runden: 26

Øst / Ingen

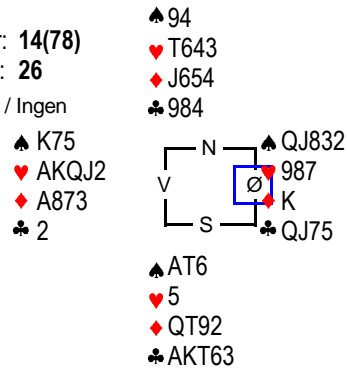

Bord	NS	ØV		NS	ØV	NS	ØV
4	23	29	4 Hjerter	V 9	50	18,0	-18,0
20	7	6	4 Hjerter	V 9	50	18,0	-18,0
2	25	27	4 Hjerter	V 10	420	14,0	-14,0
7	20	32	4 Spar	V 10	420	14,0	-14,0
10	17	35	4 Hjerter	V 11	450	-4,0	4,0
3	24	28	4 Hjerter	V 11	450	-4,0	4,0
16	11	2	4 Hjerter	V 11	450	-4,0	4,0
6	21	31	4 Hjerter	V 11	450	-4,0	4,0
12	15	37	4 Hjerter	V 11	450	-4,0	4,0
5	30	22	4 Spar	Ø 11	450	-4,0	4,0
8	19	33	4 Spar	Ø 11	450	-4,0	4,0
1	40	26	4 Spar	Ø 11	450	-4,0	4,0
11	36	16	4 Spar	Ø 11	450	-4,0	4,0
14	39	13	4 Spar	Ø 11	450	-4,0	4,0
15	12	1	4 Spar	V 11	450	-4,0	4,0
17	3	10	4 Spar	Ø 11	450	-4,0	4,0
18	4	9	4 Spar	Ø 11	450	-4,0	4,0
19	5	8	4 Spar	Ø 11	450	-4,0	4,0
9	34	18	4 Spar	Ø 11	450	-4,0	4,0
13	14	38	5 Spar	Ø 11	450	-4,0	4,0

Mappen: 15(79)
Runden: 27

Syd / N/S

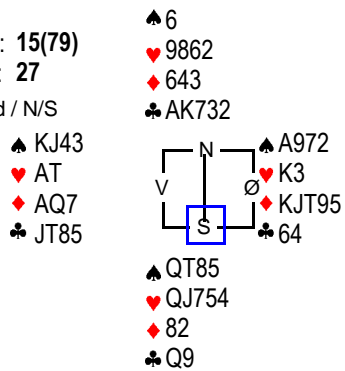

Bord	NS	ØV		NS	ØV	NS	ØV
10	18	36	5 Spar	V 9	100	19,0	-19,0
4	24	30	4 Spar	V 9	50	12,0	-12,0
1	40	27	4 Spar	V 9	50	12,0	-12,0
9	35	19	4 Spar	V 9	50	12,0	-12,0
20	8	7	4 Spar	V 9	50	12,0	-12,0
12	16	38	4 Spar	V 9	50	12,0	-12,0
18	5	10	4 Spar	V 9	50	12,0	-12,0
14	1	14	4 Spar	V 10	420	-5,0	5,0
15	13	2	4 Spar	V 10	420	-5,0	5,0
16	12	3	4 Spar	V 10	420	-5,0	5,0
17	4	11	4 Spar	V 10	420	-5,0	5,0
7	21	33	4 Spar	V 10	420	-5,0	5,0
6	22	32	4 Spar	Ø 10	420	-5,0	5,0
5	31	23	4 Spar	V 10	420	-5,0	5,0
19	6	9	4 Spar	V 10	420	-5,0	5,0
3	25	29	4 Spar	Ø 10	420	-5,0	5,0
2	26	28	4 Spar	V 10	420	-5,0	5,0
11	37	17	4 Spar	V 10	420	-5,0	5,0
13	15	39	3 NT	Ø 10	430	-18,0	18,0
8	20	34	3 NT	Ø 10	430	-18,0	18,0

Mappen: 16(80)
Runden: 27

Vest / Ø/V

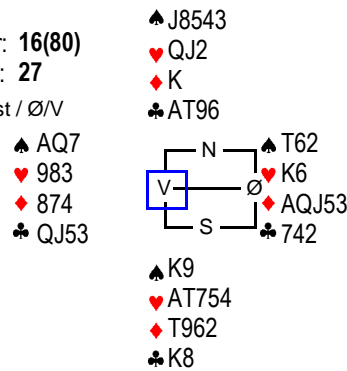

Bord	NS	ØV		NS	ØV	NS	ØV
3	25	29	4 Hjerter	N 10	420	15,0	-15,0
4	24	30	4 Hjerter	S 10	420	15,0	-15,0
16	12	3	4 Hjerter	S 10	420	15,0	-15,0
20	8	7	4 Hjerter	S 10	420	15,0	-15,0
13	15	39	4 Spar	S 10	420	15,0	-15,0
8	20	34	2 Ruter D	Ø 7	200	9,0	-9,0
14	1	14	2 Spar	N 10	170	7,0	-7,0
11	37	17	2 Hjerter	S 9	140	1,0	-1,0
10	18	36	2 Hjerter	S 9	140	1,0	-1,0
15	13	2	3 Hjerter	S 9	140	1,0	-1,0
1	40	27	3 Hjerter	S 9	140	1,0	-1,0
6	22	32	3 Hjerter	S 9	140	1,0	-1,0
5	31	23	2 Hjerter	S 8	110	-7,0	7,0
19	6	9	2 Hjerter	S 8	110	-7,0	7,0
18	5	10	2 Spar	N 8	110	-7,0	7,0
17	4	11	2 Hjerter	S 7	50	-14,0	14,0
2	26	28	3 Hjerter	S 8	50	-14,0	14,0
7	21	33	4 Hjerter	S 9	50	-14,0	14,0
9	35	19	4 Hjerter	S 9	50	-14,0	14,0
12	16	38	3 Hjerter D	S 8	100	-19,0	19,0

SPILLSTENSILER

Kragerøcupen 2008, 23.-24. august 2008

Mappen: 17(81)
Runden: 27

Nord / Ingen

♠ KT53
♥ 9
♦ AK752
♣ T84

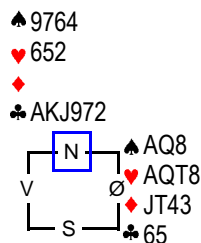

♠ J2
♥ KJ743
♦ Q986
♣ Q3

Bord	NS	ØV	NS	ØV	NS	ØV
13	15	39	3 Hjerter D	S 10	630	19,0 -19,0
9	35	19	3 NT	Ø 6	150	14,0 -14,0
7	21	33	4 Spar	V 7	150	14,0 -14,0
1	40	27	4 Spar	Ø 7	150	14,0 -14,0
10	18	36	4 Spar	Ø 7	150	14,0 -14,0
20	8	7	2 Spar	Ø 6	100	8,0 -8,0
6	22	32	4 Spar	V 8	100	8,0 -8,0
5	31	23	3 Spar	V 8	50	3,0 -3,0
12	16	38	4 Ruter	Ø 9	50	3,0 -3,0
8	20	34	4 Spar	V 9	50	3,0 -3,0
17	4	11	3 Hjerter D	S 8	100	-1,0 1,0
4	24	30	2 Spar	V 8	110	-4,0 4,0
15	13	2	3 Ruter	Ø 9	110	-4,0 4,0
19	6	9	2 NT	Ø 8	120	-7,0 7,0
14	1	14	3 Ruter	V 10	130	-11,0 11,0
18	5	10	3 Ruter	V 10	130	-11,0 11,0
3	25	29	3 Ruter	Ø 10	130	-11,0 11,0
16	12	3	2 NT	Ø 11	210	-15,0 15,0
2	26	28	4 Hjerter D	S 7	500	-17,0 17,0
11	37	17	3 Hjerter D	S 5	800	-19,0 19,0

Mappen: 18(82)
Runden: 28

Øst / N/S

♠ Q4
♥ J
♦ J64
♣ KQ97643

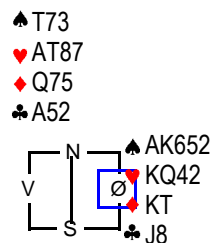

♠ J98
♥ 9653
♦ A9832
♣ T

Bord	NS	ØV	NS	ØV	NS	ØV
17	5	12	4 Spar	Ø 8	100	19,0 -19,0
11	38	18	4 Kløver	Ø 9	50	15,0 -15,0
5	32	24	4 Spar	Ø 9	50	15,0 -15,0
7	22	34	4 Spar	Ø 9	50	15,0 -15,0
18	6	11	2 Spar	Ø 9	140	9,0 -9,0
8	21	35	2 Spar	Ø 9	140	9,0 -9,0
3	26	30	3 Spar	Ø 9	140	9,0 -9,0
19	7	10	2 Spar	V 10	170	5,0 -5,0
13	16	1	3 Spar	Ø 11	200	3,0 -3,0
10	19	37	3 NT	Ø 9	400	0,0 0,0
12	17	39	3 NT	V 9	400	0,0 0,0
6	23	33	4 Spar	Ø 10	420	-3,0 3,0
14	2	15	3 NT	Ø 10	430	-7,0 7,0
15	14	3	3 NT	Ø 10	430	-7,0 7,0
4	25	31	3 NT	Ø 10	430	-7,0 7,0
20	9	8	3 NT	Ø 11	460	-13,0 13,0
2	27	29	3 NT	V 11	460	-13,0 13,0
9	36	20	3 NT	Ø 11	460	-13,0 13,0
1	40	28	3 NT	Ø 12	490	-18,0 18,0
16	13	4	3 NT	Ø 12	490	-18,0 18,0

Mappen: 19(83)
Runden: 28

Syd / Ø/V

♠ 9652
♥ KQ7
♦ AT854
♣ J

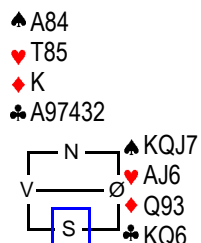

♠ T3
♥ 9432
♦ J762
♣ T85

Bord	NS	ØV	NS	ØV	NS	ØV
5	32	24	4 NT	Ø 7	300	19,0 -19,0
16	13	4	3 NT	Ø 8	100	15,0 -15,0
12	17	39	3 NT	Ø 8	100	15,0 -15,0
11	38	18	5 Kløver	V 10	100	15,0 -15,0
17	5	12	3 Ruter	V 10	130	11,0 -11,0
4	25	31	4 Spar	Ø 10	620	3,0 -3,0
6	23	33	4 Spar	Ø 10	620	3,0 -3,0
8	21	35	4 Spar	Ø 10	620	3,0 -3,0
10	19	37	4 Spar	V 10	620	3,0 -3,0
13	16	1	4 Spar	Ø 10	620	3,0 -3,0
14	2	15	4 Spar	V 10	620	3,0 -3,0
18	6	11	4 Spar	Ø 10	620	3,0 -3,0
20	9	8	3 NT	Ø 10	630	-12,0 12,0
1	40	28	3 NT	Ø 10	630	-12,0 12,0
7	22	34	3 NT	Ø 10	630	-12,0 12,0
15	14	3	3 NT	Ø 10	630	-12,0 12,0
19	7	10	3 NT	Ø 10	630	-12,0 12,0
3	26	30	3 NT	Ø 10	630	-12,0 12,0
2	27	29	3 NT	Ø 10	630	-12,0 12,0
9	36	20	3 NT	Ø 10	630	-12,0 12,0

Mappen: 20(84)
Runden: 28

Vest / Alle

♠ 2
♥ J96
♦ 8764
♣ AJ982

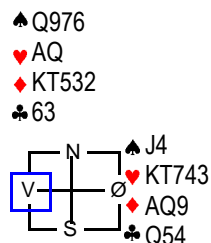

♠ AKT853
♥ 852
♦ J
♣ KT7

Bord	NS	ØV	NS	ØV	NS	ØV
11	38	18	4 Spar	N 11	650	19,0 -19,0
6	23	33	4 Spar	N 10	620	13,0 -13,0
7	22	34	4 Spar	N 10	620	13,0 -13,0
10	19	37	4 Spar	S 10	620	13,0 -13,0
20	9	8	4 Spar	N 10	620	13,0 -13,0
16	13	4	4 Spar	N 10	620	13,0 -13,0
4	25	31	2 Spar	S 9	140	6,0 -6,0
2	27	29	3 Spar	S 9	140	6,0 -6,0
15	14	3	4 Spar	S 9	100	-6,0 6,0
13	16	1	4 Spar	S 9	100	-6,0 6,0
12	17	39	4 Spar	S 9	100	-6,0 6,0
17	5	12	4 Spar	S 9	100	-6,0 6,0
1	40	28	4 Spar	S 9	100	-6,0 6,0
8	21	35	4 Spar	S 9	100	-6,0 6,0
18	6	11	4 Spar	S 9	100	-6,0 6,0
19	7	10	4 Spar	S 9	100	-6,0 6,0
3	26	30	4 Spar	S 9	100	-6,0 6,0
9	36	20	4 Spar	S 9	100	-6,0 6,0
5	32	24	4 Spar D	S 9	200	-18,0 18,0
14	2	15	5 Ruter	N 9	200	-18,0 18,0

SPILLSTENSILER

Kragerøcupen 2008, 23.-24. august 2008

Mappen: **21(85)**

Runden: **29**

Nord / N/S

♠ K87632
♥ 874
♦ KQ8
♣ K

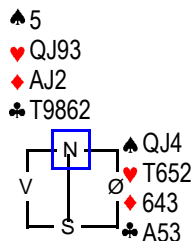

♠ AT9
♥ AK
♦ T975
♣ QJ74

Bord	NS	ØV	NS	ØV	NS	ØV
2	28	30	4 Spar D	V 8	300	19,0 -19,0
18	7	12	4 Kløver	S 10	130	14,0 -14,0
14	3	16	4 Kløver	S 10	130	14,0 -14,0
13	17	2	4 Kløver	S 10	130	14,0 -14,0
12	18	1	4 Kløver	N 10	130	14,0 -14,0
19	8	11	3 Spar D	V 8	100	4,0 -4,0
20	10	9	3 Spar D	V 8	100	4,0 -4,0
1	40	29	3 Spar D	V 8	100	4,0 -4,0
8	22	36	3 Spar	V 7	100	4,0 -4,0
4	26	32	3 Spar D	V 8	100	4,0 -4,0
17	6	13	4 Spar D	V 9	100	4,0 -4,0
16	14	5	3 Spar	Ø 8	50	-5,0 5,0
3	27	31	3 Spar	V 8	50	-5,0 5,0
5	33	25	3 Spar	Ø 8	50	-5,0 5,0
11	39	19	5 Kløver	S 10	100	-10,0 10,0
10	20	38	5 Kløver	N 10	100	-10,0 10,0
6	24	34	2 Spar	V 8	110	-14,0 14,0
7	23	35	2 Spar	V 8	110	-14,0 14,0
9	37	21	3 NT	S 6	300	-17,0 17,0
15	15	4	3 NT D	S 6	800	-19,0 19,0

Mappen: **22(86)**

Runden: **29**

Øst / Ø/V

♠ QT86
♥ T
♦ AT5
♣ AT654

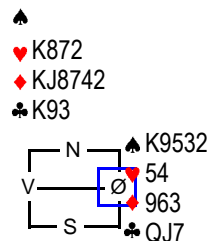

♠ AJ74
♥ AQJ963
♦ Q
♣ 82

Bord	NS	ØV	NS	ØV	NS	ØV
6	24	34	4 Spar D	Ø 6	1100	19,0 -19,0
15	15	4	4 Spar D	Ø 7	800	17,0 -17,0
13	17	2	4 Hjerter	S 11	450	1,0 -1,0
5	33	25	4 Hjerter	S 11	450	1,0 -1,0
7	23	35	4 Hjerter	S 11	450	1,0 -1,0
8	22	36	4 Hjerter	S 11	450	1,0 -1,0
1	40	29	4 Hjerter	S 11	450	1,0 -1,0
3	27	31	4 Hjerter	S 11	450	1,0 -1,0
4	26	32	4 Hjerter	S 11	450	1,0 -1,0
12	18	1	4 Hjerter	S 11	450	1,0 -1,0
10	20	38	4 Hjerter	S 11	450	1,0 -1,0
14	3	16	4 Hjerter	S 11	450	1,0 -1,0
17	6	13	4 Hjerter	S 11	450	1,0 -1,0
19	8	11	4 Hjerter	S 11	450	1,0 -1,0
20	10	9	4 Hjerter	S 11	450	1,0 -1,0
16	14	5	5 Hjerter	S 11	450	1,0 -1,0
2	28	30	5 Hjerter	S 11	450	1,0 -1,0
9	37	21	6 Hjerter	S 11	50	-15,0 15,0
18	7	12	6 Hjerter D	S 11	100	-18,0 18,0
11	39	19	6 Hjerter D	S 11	100	-18,0 18,0

Mappen: **23(87)**

Runden: **29**

Syd / Alle

♠ QJ32
♥ AT5
♦ AK4
♣ AJT

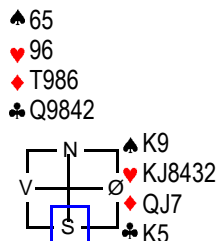

♠ AT874
♥ Q7
♦ 532
♣ 763

Bord	NS	ØV	NS	ØV	NS	ØV
15	15	4	6 Hjerter	Ø 11	100	15,0 -15,0
12	18	1	6 Hjerter	Ø 11	100	15,0 -15,0
3	27	31	6 NT	V 11	100	15,0 -15,0
5	33	25	6 NT	V 11	100	15,0 -15,0
8	22	36	6 NT	V 11	100	15,0 -15,0
9	37	21	5 Hjerter	Ø 12	680	9,0 -9,0
10	20	38	3 NT	V 12	690	6,0 -6,0
4	26	32	5 NT	V 12	690	6,0 -6,0
20	10	9	6 Hjerter	Ø 12	1430	-3,0 3,0
16	14	5	6 Hjerter	Ø 12	1430	-3,0 3,0
1	40	29	6 Hjerter	Ø 12	1430	-3,0 3,0
17	6	13	6 Hjerter	Ø 12	1430	-3,0 3,0
6	24	34	6 Hjerter	Ø 12	1430	-3,0 3,0
18	7	12	6 Hjerter	Ø 12	1430	-3,0 3,0
11	39	19	6 Hjerter	Ø 12	1430	-3,0 3,0
13	17	2	6 NT	Ø 12	1440	-15,0 15,0
14	3	16	6 NT	V 12	1440	-15,0 15,0
7	23	35	6 NT	V 12	1440	-15,0 15,0
19	8	11	6 NT	V 12	1440	-15,0 15,0
2	28	30	6 NT	V 12	1440	-15,0 15,0

Mappen: **24(88)**

Runden: **30**

Vest / Ingen

♠ K543
♥ 652
♦ KT95
♣ Q9

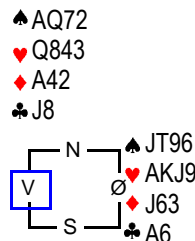

♠ 8
♥ T7
♦ Q87
♣ KT75432

Bord	NS	ØV	NS	ØV	NS	ØV
7	24	36	3 Kløver D	N 9	470	19,0 -19,0
11	1	20	4 Spar D	V 8	300	17,0 -17,0
3	28	32	3 Kløver	S 9	110	15,0 -15,0
4	27	33	3 Spar D	V 8	100	12,0 -12,0
17	7	14	4 Spar D	V 9	100	12,0 -12,0
16	15	6	1 Hjerter	N 7	80	9,0 -9,0
12	19	2	2 Spar	V 7	50	6,0 -6,0
1	40	30	3 Spar	V 8	50	6,0 -6,0
8	23	37	3 Kløver	S 8	50	2,0 -2,0
6	25	35	4 Kløver	N 9	50	2,0 -2,0
5	34	26	2 Spar	V 9	140	-7,0 7,0
9	38	22	2 Spar	V 9	140	-7,0 7,0
20	11	10	3 Hjerter	Ø 9	140	-7,0 7,0
18	8	13	3 Hjerter	Ø 9	140	-7,0 7,0
14	4	17	3 Spar	Ø 9	140	-7,0 7,0
19	9	12	3 Spar	V 9	140	-7,0 7,0
10	21	39	3 Spar	V 9	140	-7,0 7,0
15	16	5	1 NT	Ø 9	150	-15,0 15,0
2	29	31	3 NT	N 4	250	-17,0 17,0
13	18	3	3 NT D	N 5	800	-19,0 19,0

SPILLSTENSILER

Kragerøcupen 2008, 23.-24. august 2008

Mappen: 25(89)

Runden: 30

Nord / ØV

♠ T87
♥ 32
♦ J8
♣ AKQJ92

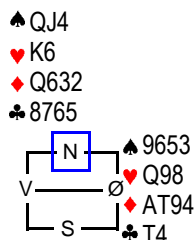

♠ AK2
♥ AJT754
♦ K75
♣ 3

Bord	NS	ØV	NS	ØV	NS	ØV
3	28	32	3 Kløver D	V 7	500	19,0 -19,0
7	24	36	4 Hjerter	S 11	450	17,0 -17,0
9	38	22	4 Hjerter	S 10	420	6,0 -6,0
19	9	12	4 Hjerter	S 10	420	6,0 -6,0
18	8	13	4 Hjerter	S 10	420	6,0 -6,0
17	7	14	4 Hjerter	S 10	420	6,0 -6,0
6	25	35	4 Hjerter	S 10	420	6,0 -6,0
14	4	17	4 Hjerter	S 10	420	6,0 -6,0
12	19	2	4 Hjerter	S 10	420	6,0 -6,0
20	11	10	4 Hjerter	S 10	420	6,0 -6,0
8	23	37	4 Hjerter	S 10	420	6,0 -6,0
1	40	30	4 Hjerter	S 10	420	6,0 -6,0
11	1	20	3 Kløver D	V 8	200	-5,0 5,0
15	16	5	2 Hjerter	S 10	170	-12,0 12,0
5	34	26	2 Hjerter	S 10	170	-12,0 12,0
4	27	33	2 Hjerter	S 10	170	-12,0 12,0
16	15	6	2 Hjerter	S 10	170	-12,0 12,0
10	21	39	2 Hjerter	S 10	170	-12,0 12,0
2	29	31	3 Hjerter	S 10	170	-12,0 12,0
13	18	3	4 Hjerter	S 9	50	-19,0 19,0

Mappen: 26(90)

Runden: 30

Øst / Alle

♠ QJ
♥ Q98732
♦ AT43
♣ 4

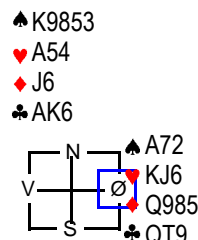

♠ T64
♥ T
♦ K72
♣ J87532

Bord	NS	ØV	NS	ØV	NS	ØV
2	29	31	3 Spar	N 9	140	19,0 -19,0
5	34	26	3 Spar	N 8	100	14,0 -14,0
14	4	17	3 Spar	N 8	100	14,0 -14,0
10	21	39	4 Spar	N 9	100	14,0 -14,0
8	23	37	4 Spar	N 9	100	14,0 -14,0
11	1	20	3 Ruter	Ø 10	130	9,0 -9,0
20	11	10	2 Hjerter	V 10	170	1,0 -1,0
12	19	2	3 Hjerter	V 10	170	1,0 -1,0
1	40	30	3 Hjerter	V 10	170	1,0 -1,0
6	25	35	3 Hjerter	V 10	170	1,0 -1,0
4	27	33	3 Hjerter	V 10	170	1,0 -1,0
3	28	32	3 Hjerter	V 10	170	1,0 -1,0
9	38	22	3 Hjerter	V 10	170	1,0 -1,0
16	15	6	3 Hjerter	V 11	200	-9,0 9,0
18	8	13	4 Spar D	N 9	200	-9,0 9,0
19	9	12	4 Spar	N 8	200	-9,0 9,0
15	16	5	4 Hjerter	V 10	620	-15,0 15,0
13	18	3	4 Hjerter	V 10	620	-15,0 15,0
7	24	36	4 Hjerter	V 10	620	-15,0 15,0
17	7	14	4 Hjerter D	V 10	790	-19,0 19,0

Mappen: 27(91)

Runden: 31

Syd / Ingen

♠ AK972
♥ KJ643
♦
♣ KJ4

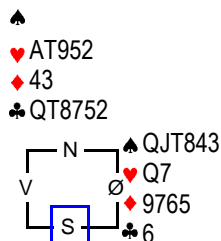

♠ 65
♥ 8
♦ AKQJT82
♣ A93

Bord	NS	ØV	NS	ØV	NS	ØV
13	19	4	6 Ruter D	S 12	1090	19,0 -19,0
19	10	13	6 Kløver	N 12	920	16,0 -16,0
12	20	3	6 Ruter	S 12	920	16,0 -16,0
9	39	23	5 Kløver	N 12	420	9,0 -9,0
3	29	33	5 Ruter	S 12	420	9,0 -9,0
4	28	34	5 Ruter	S 12	420	9,0 -9,0
7	25	37	5 Ruter	S 12	420	9,0 -9,0
11	2	21	5 Ruter	S 12	420	9,0 -9,0
14	5	18	6 Spar D	V 10	300	3,0 -3,0
15	17	6	6 Spar D	V 11	100	-2,0 2,0
8	24	38	6 Spar D	Ø 11	100	-2,0 2,0
6	26	36	6 Spar D	V 11	100	-2,0 2,0
5	35	27	6 Spar	Ø 10	100	-2,0 2,0
10	22	1	5 Spar	Ø 10	50	-7,0 7,0
17	8	15	6 Ruter	S 11	50	-9,0 9,0
2	30	32	3 NT D	S 8	100	-12,0 12,0
18	9	14	6 Kløver D	N 11	100	-12,0 12,0
20	12	11	5 Spar	V 11	450	-16,0 16,0
16	16	7	5 Spar	V 11	450	-16,0 16,0
1	40	31	4 Spar	Ø 12	480	-19,0 19,0

Mappen: 28(92)

Runden: 31

Vest / N/S

♠ QT5
♥ AQ985
♦
♣ Q9865

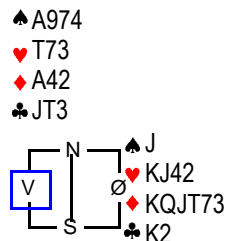

♠ K8632
♥ 6
♦ 9865
♣ A74

Bord	NS	ØV	NS	ØV	NS	ØV
10	22	1	7 NT D	Ø 9	800	19,0 -19,0
12	20	3	5 Hjerter	V 10	50	17,0 -17,0
3	29	33	4 Hjerter	V 10	420	5,0 -5,0
4	28	34	4 Hjerter	V 10	420	5,0 -5,0
5	35	27	4 Hjerter	V 10	420	5,0 -5,0
6	26	36	4 Hjerter	V 10	420	5,0 -5,0
7	25	37	4 Hjerter	V 10	420	5,0 -5,0
1	40	31	4 Hjerter	V 10	420	5,0 -5,0
9	39	23	4 Hjerter	V 10	420	5,0 -5,0
20	12	11	4 Hjerter	V 10	420	5,0 -5,0
15	17	6	4 Hjerter	V 10	420	5,0 -5,0
16	16	7	4 Hjerter	V 10	420	5,0 -5,0
19	10	13	4 Hjerter	V 10	420	5,0 -5,0
13	19	4	4 Hjerter	V 11	450	-13,0 13,0
14	5	18	4 Hjerter	V 11	450	-13,0 13,0
8	24	38	4 Hjerter	V 11	450	-13,0 13,0
17	8	15	4 Hjerter	V 11	450	-13,0 13,0
2	30	32	4 Hjerter	V 11	450	-13,0 13,0
18	9	14	5 Hjerter	V 11	450	-13,0 13,0
11	2	21	5 Hjerter	V 11	450	-13,0 13,0

SPILLSTENSILER

Kragerøcupen 2008, 23.-24. august 2008

Mappen: **29(93)**
Runden: **31**

Nord / Alle

♠ T6
♥ 83
♦ KT853
♣ K852

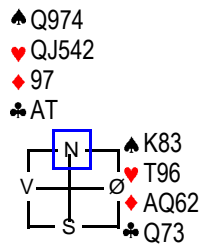

♠ AJ52
♥ AK7
♦ J4
♣ J964

Bord	NS	ØV		NS	ØV	NS	ØV
11	2	21	4 Hjerter	N 10	620	16,0	-16,0
17	8	15	4 Spar	S 10	620	16,0	-16,0
8	24	38	4 Spar	S 10	620	16,0	-16,0
15	17	6	4 Spar	S 10	620	16,0	-16,0
5	35	27	2 Hjerter	S 11	200	7,0	-7,0
4	28	34	2 Spar	S 11	200	7,0	-7,0
9	39	23	2 Spar	S 11	200	7,0	-7,0
18	9	14	2 Spar	S 11	200	7,0	-7,0
16	16	7	3 Spar	S 11	200	7,0	-7,0
7	25	37	2 Hjerter	S 10	170	1,0	-1,0
20	12	11	2 Hjerter	N 9	140	-9,0	9,0
14	5	18	2 Hjerter	N 9	140	-9,0	9,0
12	20	3	2 Spar	S 9	140	-9,0	9,0
1	40	31	2 Spar	S 9	140	-9,0	9,0
19	10	13	2 Spar	S 9	140	-9,0	9,0
3	29	33	2 Spar	S 9	140	-9,0	9,0
10	22	1	2 Spar	N 9	140	-9,0	9,0
13	19	4	3 Hjerter	N 9	140	-9,0	9,0
2	30	32	3 Spar	S 9	140	-9,0	9,0
6	26	36	4 Spar	S 9	100	-19,0	19,0